

PermaGreen™ Triumph Spreader Sprayer Operator's Manual

Model B1B with Serial Number 17550 and Above

**IF YOU HAVE ANY QUESTIONS OR CONCERNS OR ARE
MISSING PARTS OR NEED WARRANTY SERVICE,
DO NOT RETURN YOUR TRIUMPH TO THE STORE!
PLEASE CONTACT OUR SUPPORT HOTLINE AT**

800.346.2001, SUPPORT@PERMAGREEN.COM OR AT WWW.PERMAGREEN.COM

Triumph B1B Serial #: _____

Engine Serial #: GCBTT _____

Transaxle Serial #: _____ - _____



WARNING

To Avoid serious injury or death:

- This Triumph **MUST** pass a New Machine Pre-Operation Inspection prior to use.
- DO NOT** start the machine until instructed to do so during the Pre-Operation Inspection.
- Read this Manual before using.
- ALL** operators and mechanics **MUST** be trained.



WARNING

This product can expose you to chemicals including Ethyl Benzene, Naphthalene, N-Hexane, and Benzene which are known to the State of California to cause cancer and birth defects or other reproductive harm. For more information go to www.P65Warnings.ca.gov

Periodically check permagreen.com for available Triumph updates

Copyright © 2018, Perma-Green Supreme, Inc. All rights reserved. No part of this book covered by the copyright hereon may be reproduced or copied in any form or by any means, except as permitted by the proprietary data statement for use with Perma-Green Supreme, Inc. equipment, without the written permission of Perma-Green Supreme, Inc. Triumph is protected by US Patent 6.336,600 and 7,954,573 and Patents Pending.

Perma-Green Supreme, Inc. March 23, 2022 Triumph (v19) North American Version

TABLE OF CONTENTS

<u>Section</u>	<u>Page</u>
1. Introduction to using Your Manual.....	1
2. New Machine Pre-operation Inspection	2-3
3. Safety Manual.....	5-13
a) Machine Safety Labels	5
b) Warnings	8
4. Driver's Training and Operation	14-19
a. Component and Safety Device Identification	14
d. Adding Gas, Starting and General Instructions	15
e. Driving Techniques and Principles	16
f. Driving on Hillsides and Daily Service	17
g. Testing Safety Devices	18
5. Spreader Operation.....	21-24
a. Spreader Controls and Operation.....	21
b. Calibration.....	23
6. Sprayer Operation	25-27
a. Sprayer Controls	25
b. Sprayer Operation	26
c. Calibration.....	27
d. Spot Sprayer.....	28
7. Troubleshooting Manual.....	29-31
8. Service Manual	33-37
9. Plumbing and Electrical Schematics.....	38
10. Specifications.....	39
11. Warranty.....	40

Page left intentionally blank

Introduction to Using Your Manual

Congratulations on the purchase of your new **Triumph B1B Sprayer Spreader**, and welcome to the PermaGreen family! Before attempting to start or operate your Triumph, please read the Operator Manual and safety labels on the machine. Follow all the instructions carefully.

This manual explains machine inspection, operation, troubleshooting, and service, as well as, the safety features of the machine. We at PermaGreen are confident that this machine will provide you with years of excellent performance and durability when operated and maintained as directed in this manual.

This operator manual is considered a permanent part of the machine. It must be available at all times to all of the operators and persons servicing the machine. Should the machine be resold, this manual and service records are to remain with it.

An engine manufacturer's owner's manual has been provided with your machine. This will provide maintenance and troubleshooting information for the engine installed in your machine.

All information, illustrations, and specifications contained in this manual were in effect at the time of publication. Perma-Green Supreme, Inc. reserves the right to change, modify, and/or discontinue specifications and/or design without notice.

Date Purchased: _____

Model Number: **Triumph B1B**

Serial Number: _____

Dealer Name: _____

Dealer Phone: _____

New Machine Pre-Operation Inspection

Pre-Operation Inspection



Avoid serious injury!

This Triumph MUST pass a Pre-Operation inspection prior to use.

- **DO NOT** start the machine until instructed to do so.
- **DO NOT** operate unless all Safety Devices are functioning properly.
- If any Safety Device fails the inspection, contact PermaGreen Tech Support at **800-346-2001** or support@permagreen.com for replacement of any missing, damaged or malfunctioning part.
- **If you are not entirely familiar with the Safety Manual read it now before proceeding with the Pre-Operation Inspection.**



Avoid serious injury!

Lack of training, operator error, or carelessness may cause serious injury or death to the operator, mechanic, or others.

- All users, mechanics, and owners **SHALL** read and understand this Safety manual before inspecting, operating or repairing the Triumph. If you are not entirely familiar with the Safety Manual, read it now before proceeding with the Pre-Operation Inspection.



This product can expose you to chemicals including Ethyl Benzene, Naphthalene, N-Hexane, and Benzene which are known to the State of California to cause cancer and birth defects or other reproductive harm. For more information go to www.P65Warnings.ca.gov

Even though your Triumph is shipped completely assembled and tested, damage may have occurred in transit or storage. **A PermaGreen Servicing Dealer or the purchaser of the Triumph shall perform the Pre-Operation Inspection and complete and fax or mail the Warranty Registration Card to:** PermaGreen, 5609 Murvihill Rd, Valparaiso, IN 46383; support@permagreen.com; or (Fax) 219-476-7113.

While conducting the Pre-Operation Inspection, identify any unusual noises, vibration, or irregular operation. Adjust or service as required.

After the Triumph is uncrated, perform each and every step of this Pre-Operation Inspection in order.

◆ THIS SYMBOL IDENTIFIES A SAFETY CHECK

- Place the machine on level pavement.
- **Control Systems Inspection (see PAGE 14 for locations)**
 - ◆ The Throttle Lever, Front and Rear Brake Levers, Handle Release Lever, and Spray Lever shall move smoothly when pulled and automatically snap back to their original position when released.
 - ◆ The Auxiliary Throttle Return Spring is in place
 - ◆ Test operation of the Spray and Brake Levers have index finger operated locks that hold these levers in the pulled or retracted position. Pulling and releasing any of these levers automatically releases the lock.

- ◆ The Shift, Hopper, Pattern, and Deflector Levers operate push/pull cables and use friction or detents that will hold their position when released.
- ◆ Move the Shift Lever downward until it hits the top of the Neutral Stop. The machine shall roll forward easily confirming Neutral Gear has been located.
- ◆ When the Drop Handle Lever is pushed backwards, the entire Handle bar assembly will pivot up or down and shall automatically latch when placed in either position.

◆ Component Inspection

- ◆ Lock both brake levers.
- ◆ Check machine for damage, loose or missing bolts and fasteners.
- ◆ Inspect the machine to make sure all safety labels are in place. See Safety Manual for locations.
- ◆ Inspect Anti-slip Footpads for damage and adhesion.



WARNING: Avoid injury! Wear a face shield. The tires contain a liquid ballast of diluted pressurized RV antifreeze. **DO NOT** operate the machine without ballast in the tires.

◆ Tire Inspection

- ◆ With the Valve Stem in the **12 O'CLOCK** position, make sure the tire pressure is **12 PSI**.

◆ Engine and Clutch Inspection.

- Check and add **10w30** oil, if necessary, to both engine crankcase and clutch housing. **NOTE:** Do not screw dipstick in when checking level. See Engine Manual for details.
- Lubricate all moving parts. See the Service Manual for details.
- ◆ Using only the **APPROVED** gas can provided with the machine, add regular unleaded gasoline to the gas tank.
- Connect the spark plug wire.
- Open the fuel shutoff valve.
- ◆ Shift into Neutral. The machine shall easily roll forward confirming **NEUTRAL GEAR**.
- ◆ Lock both Brake Levers.
- ◆ Chock the wheels to prevent movement.
- ◆ Choke the engine, but **DO NOT** operate the Throttle Lever while starting. High engine speed causes the centrifugal clutch to engage and the machine might lurch unexpectedly during starting.
- ◆ Set the kill switch to the **ON** position.
- ◆ Have firm footing on the ground when attempting to start the Machine.
- ◆ Pull the starter cord to start the engine. After the engine starts, place the choke in the **RUN** position. **IMPORTANT: Avoid Damage!** If unusual noise or vibration is detected, stop engine and correct the problem.
- ◆ While in Neutral, the engine **SHALL** idle at no more than **1650 RPM**. **IF THE IDLE SPEED EXCEEDS 1650 RPM**, adjust the idle speed down (see Service Manual).
- ◆ While in Neutral, pull the Throttle lever. The top engine speed **SHALL** be **3450 RPM** (plus or minus **25 RPM**) at full throttle. If necessary, adjust the full throttle speed. Pull and release the Throttle Lever several times. The engine **SHALL** automatically and quickly return to idle.

◆ Neutral Safety Switch Inspection

- ◆ Following the starting procedures above attempt to start the machine in **LOW GEAR, HIGH GEAR** and **REVERSE**. It **SHALL NOT** start in gear. **IF THE MACHINE STARTS IN ANY GEAR, DO NOT CONTINUE THE TEST OR OPERATE THE MACHINE** Contact PermaGreen support and/or refer to the Troubleshooting Section for details.

◆

◆ Drive and Brake Systems Inspection

- ◆ Remove the chock blocks and unlock both Brake Levers.
- ◆ On a paved parking lot, shift into **LOW GEAR** and pull the Throttle Lever. The machine should smoothly accelerate to about **3.5 MPH**.
- ◆ Pull the Rear Brake Lever. Both rear wheels should drag equally without causing a change of course, left or right.
- ◆ Accelerate again and carefully pull the Front Brake Lever. When applied, the front brakes shall not lock up.
- ◆ Stop. Repeat the acceleration and brake tests in **HIGH GEAR**. Top speed shall not exceed **5 MPH**.
- ◆ At top speed, the Rear Brakes alone shall bring the machine to a smooth stop within **8 FEET**.
- ◆ The Front Brakes alone shall do the same.
- ◆ Applying both Front and Rear Brakes together should stop the machine in less than the length of the machine.
- ◆ Shift into **REVERSE GEAR**. The machine should back up under power.

● Spray System Inspection (see PAGE 25 for locations)

- Fill the tanks with water. Open the Suction valve and the Fill Valve. Place a collection bucket under the Fill Valve. Start the engine and run it at high speed until the Spray System is primed. Close the Fill Valve. **NOTE: To prevent freeze damage, the Spray System has been tested using a diluted RV antifreeze/water solution, and then drained.** Many local regulations permit small quantities of RV antifreeze to be disposed of in the sanitary sewer system. Check your local regulatory agency for proper disposal.
- Check for and repair any leaks.
- With the collection bucket in place, spray through each nozzle individually to purge the lines of RV antifreeze/water solution.
- Adjust the position of each nozzle. Refer to Spray System Instructions.

● Spreader System Inspection (see PAGE 21 for locations)

- Operate the Hopper Lever to completely open and close the hopper holes. Vibration shall not cause the Hopper Lever to move.
- The Rate Control Knob is in place.
- Operate the Third Hold Lever to close or reveal the Third Hole in the hopper.
- Operate the Deflector Lever. Neither bouncing nor vibration should cause the Deflector to change position.

◆ Fully Loaded Brake Inspection

- ◆ Place planking on top of the Screen in the Hopper to protect the agitator and the screen.
- ◆ Put **150 POUNDS** of weight into the Hopper.
- ◆ With the tanks filled, repeat the braking tests stated above in

the Drive and Brake System Inspection.

- ◆ Drop the handlebar and walk up a **17 DEGREE** incline, stop the machine and apply and lock both Front and Rear Brakes. The brakes shall prevent the machine from moving.
- ◆ Repeat the test heading down the incline.

◆ Steering System Inspection

- ◆ With the machine fully loaded, drive through a series of lock to lock figure eights for 5 minutes. The steering effort to come out of the tightest turn shall be less than **30 Pounds** of force.
- ◆ The Steering brakes bands shall not overheat.

◆ Delivery Instructions for Dealers and/or purchasers

- ◆ Review the Operator's Manual, Safety information, operating instructions, and controls with the purchaser.
- ◆ Purchasers shall be made comfortable with the proper operation of the Triumph prior to using the machine.
- ◆ The Triumph Warranty Registration Form shall be completed, signed and dated by the purchasing Dealer and Inspector, and faxed or mailed to PermaGreen within **14 DAYS**. PermaGreen, 5609 Murvihill Rd, Valparaiso IN 46383 or (fax) 219-476-7113.
- **NOTE: The limited Warranty is not valid unless a completed Triumph Warranty Registration Form is received by PermaGreen with 30 DAYS of purchase.**

◆ Dealer Delivery Instructions and Obligations

- 1) Complete the New Machine Pre-Operation Inspection.
- 2) **Complete and return to PermaGreen the Warranty Registration Card within 10 DAYS.**

NOTE: If Dealer is unable to complete the Inspection or Warranty Registration Card, Dealer shall notify the customer of their obligation to do so.

- 3) Dealer shall provide the purchaser:

A) Verbal instructions of their obligation to read the Triumph Operator's Manual and the Safety Instructions contained therein, as well as, to conduct the New Machine Pre-Operation inspector if not performed by the Dealer.

B) The Triumph Operations Manual with the serial number that matches the Triumph being delivered.

C) The Triumph Warranty Registration Card with the serial numbers that matches the Triumph being delivered.

D) Engine Operation Manual

E) Squeeze and Spray spot sprayer.

F) Hopper cover

G) Calibration Gauge set

H) Approved Gas Can & 6" extension for Gas Can.

I) Sample packet of **STA-BIL**® fuel additive.

J) Spray Shield

K) Hopper Screen

Page left intentionally blank

WARNING ALL USERS AND OWNERS SHALL READ AND UNDERSTAND THIS SAFETY MANUAL BEFORE OPERATING THE TRIUMPH. LACK OF TRAINING, OPERATOR ERROR OR CARELESSNESS MAY CAUSE SERIOUS INJURY OR DEATH TO THE OPERATOR OR OTHERS.

Understanding Safety Messages

This manual and the labels on the machine contain messages to bring to your attention to potential safety concerns, machine damage, operation, and maintenance information. Please read all the special messages carefully to avoid injury and machine damage.



Safety symbols

WARNING
The word “**WARNING**” along with this safety symbol identify a potentially hazardous situation which, if not avoided, may cause serious injury or death.

CAUTION
The word “**CAUTION**” along with this safety symbol identify a potentially hazardous situation which, if not avoided, may cause minor or moderate injury.

***IMPORTANT:** The word “**IMPORTANT**” identifies a situation which may cause damage to the machine or other property.*

NOTE: The word “**NOTE**” identifies useful information which may be helpful to the operator or mechanic.

WARNING
This product can expose you to chemicals including Ethyl Benzene, Naphthalene, N-Hexane, and Benzene which are known to the State of California to cause cancer and birth defects or other reproductive harm. For more information go to www.P65Warnings.ca.gov

NOTE: Tampering with emission controls and components by unauthorized personnel may result in severe fines or penalties.

Emission controls and components can only be adjusted by EPA and/or CARB authorized service centers. Contact PermaGreen or your PermaGreen dealer with emission controls and component questions.

The engine used on your Triumph has been certified with the United States Environmental Protection Agency (EPA) and California Air Resources Board (CARB) for use in the United States and Canada in off-road mobile equipment. The emissions warranty is for 500 hours.

Machine Labels

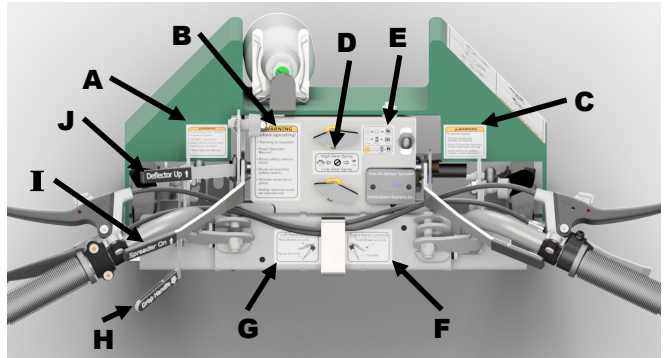

FIGURE 1, Dashboard Labels

Machine WARNING Labels (Refer to FIGURE 1)

- A) WARNING**
To avoid injury! Preview work area; Identify all hazards; Shut off machine and lock brakes whenever leaving. Read additional Safety Labels on this machine.
- B) WARNING**
Before operating: Training is required; Read operator's Manual; Read safety instructions; Read all machine safety labels; Shields must be in place; Safety devices must be operational.
- C) WARNING**
To avoid tip-over, rollover or loss-of-control: **DO NOT** operate on slopes where traction and stability are doubtful; Read Operator Manual.

Machine Information Labels

- D) Spray Selector Valve**
- E) Starting**
- F) Right Hand Controls**
- G) Left Hand Controls**
- H) Drop Handle**
- I) Hopper On**
- J) Deflector Up**

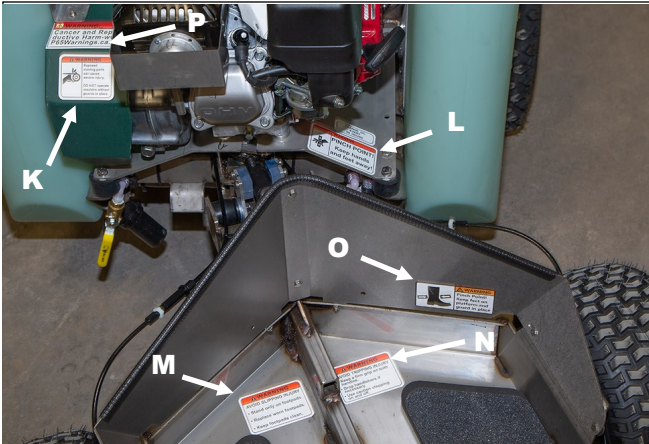

FIGURE 2, Rear Labels

**Machine WARNING Labels
(Refer to FIGURE 2)**

- K) WARNING (DUPLICATE LABEL ON FRONT HOOD)**
Exposed moving parts can cause severe injury. **DO NOT** start engine or operate machine without guards in place.
- L) WARNING**
PINCH POINT! Keep hands and feet away
- M) WARNING**
AVOID SLIPPING INJURY. Stand only on footpads; Replace worn footpads; Keep footpads clean.
- N) WARNING**
AVOID TRIPPING INJURY. Keep a firm grip on both handles. Drop handlebars if necessary. Use caution stepping on and off.
- O) WARNING**
PINCH POINT! Keep feet on platform and guard in place.
- P) WARNING**
Cancer and reproductive harm. www.P65Warnings.Ca.Gov

**Machine WARNING Labels
(Refer to FIGURE 3)**

- Q) WARNING**
Tip-over, rollover or loss-of-control may cause death or serious injury. This machine has a high center of gravity and turf conditions affect stability. **DO NOT** operate on slopes where traction and stability are doubtful. To help avoid tip-over, rollover and loss-of-control, use extreme caution on hillsides and:
- Study terrain and plan a safe operating pattern.
 - **DO NOT** operate on slopes over **15 DEGREES**.
 - Use **LOW GEAR** on hills and lean uphill for balance.
 - Avoid traveling straight down hill. Instead, zigzag down using brakes to slow descent.
 - Travel across the grade, beginning at the bottom and work your way up.
 - Avoid sharp turns and sudden starts and stops.
 - Apply rear brakes first and then front brakes.
 - Reduce the amount of granular and liquid products carried.
 - Operate as a walk-behind in situations where tip-over, rollover or loss-of-control is possible.



FIGURE 3, Panel Labels

R) WARNING

Improper operation and improper maintenance of this machine may cause death or serious injury. **DO NOT** operate the machine if:

- Engine speed exceeds **3,450 RPM**.
- Machine moves unexpectedly when starting or shifting into gear.
- You detect any unusual noise or vibration.
- You are underage or under the Influence of drugs or alcohol.
- Conditions are wet or there is low light.
- A passenger is on board. Inspect the work area and identify all hazards present first. Stay clear of drop-offs, holes, debris or other hazards. Before shifting gears, stop and then shift. Before leaving the operator position, park on level ground, lock brakes, shut off the engine, and shift into **NEUTRAL**. Perform daily and weekly maintenance. Refer to the Operator Manual for details.

S) WARNING

Operation by an untrained person may cause death or serious injury to the operator or others. **DO NOT** operate until you have read and understand the Operator Manual and Safety Information. **DO NOT** operate until you receive and understand the following training:

- Machine Safety Labels.
- Operator controls.
- Safety Devices.
- Supervised Driver's Training with enough practice time so you can safely control the machine on hills.
- Pesticide handling safety.
- Fuel handling safety. The owner of this machine is responsible for training operators and mechanics. If you cannot read English, the owner must explain the material to you. The Operator Manual is part of this machine and **MUST** be available to the operator and mechanics at all times.

Machine Information Labels

T) Shift Pattern

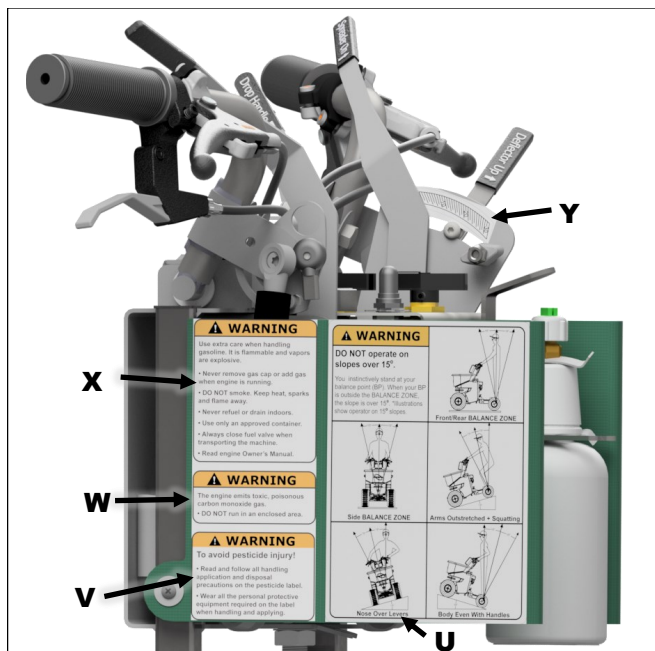

FIGURE 4, Side Labels

**Machine WARNING Labels
(Refer to FIGURE 4)**

U) WARNING

DO NOT operate on slopes over **15 DEGREES**. You instinctively stand at your balance point (BP). When your BP is outside the **BALANCE ZONE**, the slope is over 15°. *Illustrations show operator on 15° slopes.

V) WARNING

To avoid pesticide injury: Read and follow all handling application and disposal precautions on the pesticide label; Wear all the personal protective equipment required on the label when handling and applying.

W) WARNING

The engine emits toxic, poisonous carbon monoxide gas; **DO NOT** run in an enclosed area.

X) WARNING

Use extra care when handling gasoline. It is flammable and vapors are explosive. Never remove gas cap or add gas when engine is running; **DO NOT** smoke. Keep heat, sparks and flame away; Never refuel or drain indoors; Use only an approved container; **ALWAYS** close fuel valve when transporting the machine; Read engine Owner's Manual.

Machine Information Labels

Y) Rate Gauge

**Machine WARNING Labels
(Not Shown)**

ON FRONT HOOD

Exposed moving parts can cause sever injury. **DO NOT** operate machine without guard in place.

UNDER HOOD

If you can read this sign, a guard has been removed. **DO NOT** operate with guard removed.

UNDER REAR BELT GUARD

If you can read this sign, a guard has been removed. **DO NOT** operate with guard removed.



**Machine Information Label
(Refer to Serial Number Plate)**

Z) Serial Number Plate:

MANUFACTURED BY: PermaGreen™
5906 Murvihill Road Valparaiso, IN 46383
Phone #800-346-2001.
Website: www.permagreen.com

MODEL: TRIUMPH B1B
SERIAL NUMBER: XXXXX
U.S. PATENTS 6,366,600; 7,954,573 and patents pending.
Permagreen is a Registered Trademark of Perma- Green Supreme, Inc.

1

**WARNING****Owner's Responsibility**

To avoid injury: The owner is responsible for training himself and all other operators and mechanics. Before starting the engine and/or operating the machine, each operator must read and understand the Operator Manual, the Safety Manual and all other training material. If the person cannot read English, the owner is responsible to explain the material to them. Training **MUST** include **SUPERVISED** driver's training with adequate practice time for the operator to become competent in controlling the machine under all conditions.

It is the owner's responsibility to perform the maintenance as described in the Service Manual section. The owner/user can prevent and is responsible for accidents or injuries occurring to themselves, other people or property.

2

**WARNING****Supervised Driver's Training is Required for all operators and mechanics**

An untrained operator or mechanic can cause an accident with serious injury to himself or bystanders.

- All operators and mechanics **MUST** be trained. The owner is responsible for training the users.
- Driver's Training should be conducted under the direct supervision of an experienced PermaGreen operator. If one is not available, contact PermaGreen for additional assistance.
- Trainee must read the Operator's Manual including the Safety Manual prior to starting the engine. If the operator or mechanic cannot read English, it is the owner's responsibility to explain the material to the users.
- The Driver's Training and Operation section provides a step by step outline of what shall be covered during training.
- The trainer shall supplement the training procedures provided in the Driver's Training and Operation section with any additional instruction he deems necessary to ensure the safe operation of the Triumph. The Trainer should add additional instruction as necessary to provide the Trainee with additional useful information.
- The trainer should supplement the presentation of material in the Driver's Training and Operation section with instruction and references to all **WARNING** messages that appear in the Safety Manual and machine **SAFETY LABELS**.
- At each point where the trainee is to learn a new phase of driving the machine, the trainee **MUST** be provided adequate practice time to demonstrate the ability to satisfactorily control the machine while starting, stopping, turning, getting on and off, or other task described in that point before proceeding to the next phase.
- Initial training should take place on a flat open area free of obstructions with the Triumph in **LOW GEAR**.
- As the trainee progresses to more advanced phases of training the degree of difficulty may be increased, but at each phase the initial training must begin on terrain that has a low degree of difficulty. This is particularly important to keep in mind when learning how to operate on inclines and slopes.
- The Trainer shall demonstrate the principles covered in each phase.
- The Trainee shall be required to use only **LOW GEAR** for the first few days of unsupervised operation.

3

**WARNING****Minimum Operator Qualifications**

Avoid serious injury!

An Operator of this machinery must meet the following qualifications:

- The operator must be an experienced professional lawn care technician who possess a demonstrated ability to apply fertilizer and pesticide products correctly.
- The operator must meet all state Pesticide Applicator Certification requirements.
- The operator must be at least **18 YEARS OLD**.
- The operator must be physically fit and able to lift **50 POUNDS** with ease.
- The operator must weigh **BETWEEN 120** and **300** pounds.
- Has read and understands the information contained this manual. Never let children or untrained people operate or service the equipment. Local regulations may restrict the age of the operator.

4

**WARNING****Operator clothing and Personal Protection Equipment (PPE)**

- Always read and follow Pesticide labels and MSDS sheets requirements for Personal Protective Equipment.
- Wear substantial water proof footwear and tightly secure all laces and straps.
- **DO NOT** wear shorts. Instead always wear close fitting clothing and jackets to prevent clothing from getting caught on the handle bars and other control levers.
- Wear appropriate clothing including hard hat, safety glasses and hearing protection. Long hair, loose clothing, straps, shoelaces or jewelry may get caught in moving parts.

5

**WARNING****Safety Devices**

DO NOT Operate machine unless all Safety Devices are in place and in good working condition.

Safety Devices include:

- Machine Safety Labels .
- Operator Presence Control/Throttle/Centrifugal Clutch. Letting go of the Throttle lever disengages power to the drive wheels.
- Front and rear Brakes with Lock. Front brake has a spring to limit the force applied to reduce the possibility of lock-up. Locked brakes are parking brakes.
- Drop down handle. Allows operator to walk-behind machine.
- Slip resistant footpads.
- Belt and pulley covers on engine and hood.
- Neutral Safety Switch System which prevents the Triumph from starting in gear.
- Articulating bolt lock. Prevents unintentional loosening of lower bolt.
- Articulating Safety Link which prevents unintentional disengagement of the Sulky from the front frame.
- Fluid filled tires which provide ballast for a lower center-of-gravity.
- SmartSteer Brake Assist Steering System.
- Belt and Pulley Guards

6



Operation

Avoid serious injury!

- **DO NOT** change the engine governor setting or over speed the engine. The top engine speed when the machine is in Neutral is **3450 RPM**. Use the electronic multifunction display to monitor the top speed and make adjustments as necessary.
- Never shift gears while the machine is moving as this may cause a rapid slowdown or stop the front wheels causing loss-of-control or a tip over. Always, stop the machine before shifting gears.
- Only operate in good visibility conditions. Avoid holes and inspect work area for hidden hazards before starting machine engine.
- Be sure the machine is in **NEUTRAL** and all brakes are locked before starting engine.
- Adequate and reliable footing is necessary to safely operate this machine. Walk, don't run. Never operate on wet grass. Reduced footing could cause slipping. Use caution stepping on or off the sulky to avoid tripping.
- Use extra care when operating this machinery on inclines or slopes. Be sure to refer to the Operator's Manual for specific instructions regarding operating the machinery on slopes and/or inclines. Turf conditions can affect the machine's stability. Use caution while operating near drop-offs or other hazards.
- Never operate with the guards not securely in place. Be sure all interlocks are attached, adjusted properly, and functioning properly before starting the engine.
- Stop on level ground, lock all brakes, shut off engine, and shift into neutral before leaving the operator's position for any reason.
- Keep hands, feet, clothing and loose objects away from moving parts and pinch points.
- Never carry passengers. Keep a safe distance between the machine and all third parties.
- Slow down and use caution when making turns and/or crossing roads and sidewalks.
- Do not operate the machine under the influence of alcohol or drugs.
- Use care when loading or unloading the machine into a trailer or truck.
- Avoid distractions, including but not limited to cell phones and MP3 players, while operating this machine. Operators must concentrate and focus on the safe use of this machinery at all times.
- Keep a firm hold on the handlebars at all times.
- **DO NOT** touch hot muffler while running or after shutdown.
- Wear eye protection and other necessary Personal Protection Equipment (refer to Pesticide Label) when using compressed air or water to clean the machine. Regulate the pressure to **29 PSI** (200 Kilopascals).

7



Inspecting work area

Prior to operating, carefully inspect the work areas for hazards or uneven ground that may be hidden in the grass.

- Clear the work area of moveable objects such as branches, wires, rocks, glass, etc. That may interfere with the machine.
- Mark the location of all immovable objects or irregular areas.
- Avoid hitting obstacles such as holes, abrupt changes in ground contour, branches, stumps, roots, protruding pipes, paving edges, etc. that could unexpectedly turn, stop, or upset the machine possibly throwing you off, into or over the handle bars causing serious injury or death. **The faster you are moving, the more potential there is for injury.**
- Keep away from drop-offs, the edges of ponds, streams, pools, etc. especially at the bottom of slopes.

Evaluate the terrain.

- Determine what accessories and attachments are needed to properly and safely perform the job. Only use accessories and attachments approved by the manufacturer.
- Study the terrain and plan a safe operating pattern. If no safe operating pattern exists **DO NOT** attempt to drive the Triumph in that area.
- If hills are present, refer to additional Warnings in Hillside Operation in this section.

Evaluate the turf conditions.

- **DO NOT** operate if conditions are wet or there is low light.

8



Fuel Safety

Use extra care when handling gasoline and other fuels. They are flammable and vapors are explosive.

- **ALWAYS** shut off fuel valve when transporting or storing the machine.
- Use only the approved container supplied with the machine.
- Never remove gas cap or add fuel when engine is running or hot. Allow it to cool first.
- **DO NOT** smoke and stay clear of any sparks or open flames.
- Never refuel or drain the machine indoors. Move machine outdoors instead.
- Clean up fuel spills immediately. **DO NOT** attempt to start the machine near a fuel spill. Move it away instead. If fuel is spilled on clothing; **DO NOT** attempt to start the machine, stay way from open flames, sparks or other sources of ignition, and change clothing.

The engine gives off carbon monoxide, a poisonous gas.

- **DO NOT** run engine in an enclosed area or indoors.

Prevent fires.

- Keep engine clean and free from debris.
- Clean up spilled fuel.
- Check and repair leaking fuel lines, fittings and cap.
- **DO NOT** park near an open flame or other source of ignition, such as a furnace or water heater.

9

**Inspect machine before each use**

Examine the machine prior to each use. **DO NOT** use the machine if any parts are not in good working condition.

- Check for worn tires, cracks in parts, loose or missing bolts, cotter pins etc. and replace or repair before operating.
- Make sure all safety devices are present and in good working order, including all the safety labels, Shields, Brakes, the Neutral Safety Switch System, and the Operator Presence Control/ Throttle/Centrifugal Clutch (CPC) which disconnects the power to the drive wheels when released. (To test the Brakes, Neutral Safety Switch System, and OPC/Throttle/clutch, follow instructions in the Driver's Training and Operation section of this manual). Read Safety Manual **WARNING 5**.
- Make any necessary repairs or adjustments before starting the engine and/or operating the machine.

10

**Engine Starting Safety**

To avoid injury when starting:

- **DO NOT** attempt to start the machine if any of the following apply:
 - You are in a confined space.
 - You or someone else could be trapped between the machine and a solid obstacle should the machine unexpectedly move upon startup. Remember to check for low hanging obstacles such as tree branches, clotheslines, etc.
 - You are not certain of firm, dry, level footing to prevent loss of balance.
- Before attempting to start engine:
 - You must move the machine to a solid, level, dry, open area before starting the engine.
 - Verify the machine is in Neutral. The machine rolls forward easily in neutral.
 - Lock all brakes.
 - **DO NOT** operate the Throttle/Clutch.
- **DO NOT** attempt to start or operate the machine if:
 - The Neutral Safety Switch System or any other safety device is not working.
 - The Throttle/Clutch/OPC does not move freely and automatically and rapidly return to the idle position.
 - The idle engine speed exceeds **1650 RPM** upon starting.
 - The machine unexpectedly moves upon starting or when shifting gears.
 - Make repairs or adjustments as necessary prior to starting or operating the machine.

11

**Avoiding slipping or tripping injury**

Use caution when riding on, and getting on and off the Triumph.

- Keep a firm grip on the handles with both hands.
- Stand only on the footpads. .
- Keep footpads clean.
- Replace worn or damaged footpads.
- Use caution stepping on or off Driver's platform.

12

**Forward operation**

Loss-of-control may cause death or serious injury.

- Always keep a firm grip on the handlebars with both hands.
- Operate the machine in **LOW GEAR** until you become familiar with it.
- Never operate the machine at a greater speed than is reasonable in light of the conditions presented.
- Only operate in **LOW GEAR** on slopes, inclines, bumpy ground, or high grass.
- Avoid sudden starts, stops and turns as they may cause you to lose your balance and be thrown from the machine.

13

**Reverse operation**

Loss-of-control may cause death or serious injury.

- Always keep a firm grip on the handlebars with both hands.
- **DO NOT** back up if there is a possibility you or a bystander could become trapped between the machine and an immovable object or barrier.
- Always look behind and down before backing up to be sure of a clear path.
- Always look behind and up before backing up to be sure the path is clear of low hanging obstacles such as tree branches, clothes lines, and low doorways.
- Use extra caution backing up when in an enclosed area.
- Backup slowly, until you become familiar with how the machine handles.
- Never coast backwards. Instead back up under power and in **REVERSE GEAR** with the Throttle/Clutch engaged using the brakes as necessary.
- Use extra caution backing from an awkward location or position.
- Keep both feet firmly on the footpads whenever possible.
- Backing up while in the walking position is hazardous and in most cases can and should be avoided. However, when backing up from the walking position is unavoidable (such as when unloading the machine from a trailer), use extreme caution.
- **DO NOT** back up if there is any possibility that you could lose your footing or become trapped between the machine and an immovable object such as a tree or building.
 - Back in Reverse Gear with the Throttle/Clutch engaged using the brakes as necessary.

14

**Parking**

Anytime you leave the operator position, you must:

Stop on level ground.

- Turn off the engine.
- Lock both Brake Levers.
- Shift into **NEUTRAL**.

Never leave the machine unattended on an incline or slope where someone could disengage the brakes and the machine could roll.

When leaving the machine unattended, close fuel shut off valve.

15



To avoid Loss-of-control, tip-over, and rollover

Loss-of-control, tip-over or rollover may cause death or serious injury. This machine has a high center of gravity and turf conditions affect stability. Slopes are a major factor in loss-of-control, tip-over, and rollover accidents.

- Never shift gears while the machine is moving as this may cause a rapid slowdown or stop the front wheels causing loss-of-control or a forward tip over. Instead, bring the machine to a complete stop before shifting gears.
- Study the terrain before beginning work and plan a safe operating pattern. If the area at issue will not accommodate a safe operating pattern, **DO NOT** attempt to drive the Triumph in that area.
- **DO NOT** operate on slopes or inclines where traction and stability are doubtful.
- **DO NOT** ride on slopes exceeding **15 DEGREES**. Read Machine Safety Label and Safe Balance Zone sections for details on estimating **15 DEGREE** slopes before starting or operating the Triumph.
- Never operate on wet slopes.
- Look for holes, ruts, rocks, and other hidden hazards in the work area before starting work. Uneven terrain can overturn the machine. Tall grass can hide hazards.
- **DO NOT** operate near drop-offs, ditches, or bodies of water.
- Keep a firm grip of the handlebars with both hands at all times.
- Slow down and lean into turns for better balance and to transfer your weight to the inside wheels to prevent loss-of-control, tip over, or rollover.
- Tires with excessively worn tire tread are dangerous on slopes or inclines. Replace tire(s) with less than **1/4"** of tread remaining. Only use liquid filled tires supplied by PermaGreen. Maintain tire pressure at **12 PSI**. Higher pressures will cause the tires to lose traction and under inflated tires will cause instability.
- **DO NOT** attempt to climb over curbs and parking blocks while operating the Triumph at a high speed as this may cause a forward tip-over.
- To help avoid Loss-of-control, tip over, and rollover, use extreme caution on inclines, and slopes and:
 - Use **LOW GEAR** to provide improved traction and a slower ground speed.
 - Travel across the grade. Begin at the bottom of the slope and work your way up.
 - Avoid traveling straight down a slope. When descending a slope, zigzag or slalom across the grade gradually downwards using the brakes to slow the machine.
 - Lean uphill at all times to provide better balance and to transfer weight to the uphill tires.
 - Slow down and avoid sharp turns and sudden starts and stops.
 - Reduce the amount of granular and liquid products carried.
 - Apply rear brakes first and then front brakes.

Operate the Triumph as a walk-behind unit in situations where loss-of-control, tip-over, or rollover is possible.

When traveling up a slope, be aware that the drive tires have reduced traction and there is greater risk that the machine could tip backwards.

Recommendations for driving up an incline or slope:

- Lean forwards to provide better balance and to transfer

more weight to the front drive wheels. Refer to the driver's position illustrations in Driver's Training and Operation section of this Manual for details.

- Accelerate gently. Accelerate slowly. Accelerating too quickly may result in a loss of traction.
- **DO NOT** make sharp or quick turns. Making sharp or quick turns may cause you to lose your balance and be thrown off the machine or cause a side rollover.
- In areas of poor traction, operate the machine as a walk behind unit.
- If you experience a loss of control while driving the machine on an upward slope, lower the handlebars as you step backwards off the operator's platform and apply the brakes. Once the brakes are applied, take corrective action.
- Backing down a slope is a hazardous maneuver which should be avoided. To avoid backing down a slope; stop the machine, apply the brakes, step off the Driver's platform, drop the handlebars, steer the front of the machine across the grade, and gradually engage the Throttle/Clutch. If backing down a slope is unavoidable (such as when unloading the machine from a trailer), use extreme caution. Read Safety Manual **WARNING13**, Reverse Operation, for details on backing up.

When pointing downhill, the weight and traction is transferred to the front drive wheels. Avoid driving the machine at this angle since the machine may tip over.

Recommendations for driving downhill:

- Lean backwards as you travel downhill to provide better balance for you and transfer more weight to the rear wheels. If necessary, extend your arms and squat down backwards with arms extended to transfer more weight further to the rear.
- Do not change speed suddenly. **DO NOT** accelerate. Decelerate gently by applying the rear brakes first followed by the front brakes.
- Use extreme caution when turning. **DO NOT** make sharp turns as you may lose your balance and/or be thrown from the machine or loose control. When making turns, slow down and make gradual turns.
- Zigzag or slalom slowly and gradually downhill traveling across the grade using both brakes to slow your speed. The steeper the slope the more gradual the slaloms should be between the switchbacks.
- Avoid any obstacles that could suddenly stop the front wheels causing a tip over.
- If you ever loose control while driving down a slope, let go of the handles and jump off to the rear, if necessary.
- Backing uphill is a risky maneuver which should be avoided. To avoid backing uphill; stop the machine, apply the brakes, step off the Driver's platform, drop the handlebars, steer the front of the machine across the grade, and gradually engage the Throttle/Clutch. When backing uphill is unavoidable, use caution. Read Safety Manual **WARNING 13**, Reverse Operation, for details on backing up.

When pointing across an incline, slope or hill sideways, the weight distribution between the front drive wheels and the rear wheels is similar to level ground. However, more weight is transferred to the lower wheels which may cause the machine to rollover towards the downhill side. This is the preferred angle for driving on gentle slopes.

When pointing across an incline... (continued)

Recommendations for driving across a hillside:

- Lean uphill to provide better balance for you and transfer more weight to the uphill wheels.
- **DO NOT** change speed suddenly.

- **DO NOT** make sharp turns as you may lose your balance and be thrown off the machine or loose control. When making turns, slow down and make gradual turns. The machine also has a tendency to rollover when performing this maneuver.
- Avoid making downhill turns as the machine will accelerate through the turn making it more difficult for you to keep your balance and control over the machine so as to prevent rollover.
- Avoid any obstacles that could suddenly pitch the front uphill wheel upwards causing a rollover towards the downhill side.
- If you ever loose control while driving across a slope let go of the handles and jump off to the uphill side of the machine, if necessary.

Backing up across the grade is a maneuver which in should be avoided. To avoid backing up; stop the machine, apply the brakes, step off the Driver's platform, drop the handlebars, steer the front of the machine in the desired direction, and gradually engage the Throttle/Clutch. When backing up is unavoidable, use caution. Read Safety Manual **WARNING 13**, Reverse Operation, for details on backing up.

16

**WARNING****Transporting**

Driving up and down ramps is hazardous. The risks include tip-over, rollover, loss-of-control, and back-over.

Use extreme caution when driving the Triumph onto and off of a Transport, (such as a vehicle, carrying rack, or trailer).

- When loading and unloading, park the Transport on level pavement well away from puddles, obstacles, and curbs that may cause the operator to loose his footing or become entrapped. Allow adequate room for the ramps to be deployed and the machine and operator to come straight on or off the Transport platform and ramps.
- To prevent a ramp from slipping out from under the machine, make sure the ramp is securely fastened to the Transport platform and the ramp and machine wheels are properly aligned with each other.
- Never unload a Triumph by shifting it into **NEUTRAL** and allowing it to freewheel backwards down a ramp. Rather, the driver must start the Triumph while on the Transport platform, shift the engine into **REVERSE**, and inch the machine down the ramp under power using the brakes as necessary. Read Safety Manual **WARNING 13**, Reverse Operation, for required precautions while operating the Triumph in reverse.
- If there is not adequate standing room for the operator on the Transport platform, the machine should be started while the operator is standing on the ground.
- If an enclosed Transport is used, use extra caution starting and operating the Triumph inside the enclosure.

Transporting the machine over the road can be hazardous. The risks include but not limited to traffic accidents, failure of Transport system, and ejection of the machine from the Transport.

Transporting the Triumph requires a heavy duty Transport capable of safely carrying a fully loaded Triumph weighing **700 Lbs** (318 Kg) plus the weight of all materials carried on the transport.

- Follow other Transport manufacturer's precautions and always use all safety devices provided.
- **DO NOT** overload or unbalance the Transport or hitch.
- Use only heavy duty ramps with a minimum width of **8.5 Inches** (216 mm) and an anti-slip surface capable of supporting **1000 Lbs** (455 Kg) or the combined weight of the machine and driver whichever is greater. The ramp angle must be **15 DEGREES** or less.
- To prevent the machine from being thrown from the transport, always secure the machine to the Transport's platform. Use securing devices provided by the manufacturer or securing devices each securing device or all securing devices together must have a minimum load rating of **1,400 Lbs** (636 Kg). Elastic straps and similar devices are **NOT** to be used.
- Check Transport, ramps, hitch, and securing devices each time they are used.
 - Check carefully for cracked welds or cracked parts, loose or missing hardware, excessive wear or damage, or missing or nonworking safety and securing devices.
 - When a carrying rack is used, check for damage caused by the rear edge dragging or bottoming out on the pavement. This can result in structural failure of the rack, hitch and vehicle frame or hardware.
 - **DO NOT** use the Transport if it is not in good working condition. Make necessary repairs or replacements before using.

17

**WARNING****Check wheel fasteners**

If wheel fasteners are not tight, a serious accident may occur.

- Check wheel fastener tightness frequently during the first **100 HOURS** of operation.
- After loosening any wheel fasteners, frequently check their tightness for the next **100 HOURS** of operation.

18

**Tire Safety**

Tires are filled with pressurized diluted RV antifreeze to provide ballast for a lower center of gravity. Explosive separation of rim and tires may cause serious injury.

- **DO NOT** remove fluid from tires.
- All replacement tires must be fluid filled.
- Wear a face shield when checking, filling, and repairing fluid-filled tires.
- Refer to the Service Manual for instructions on repairing fluid filled tires.
- Do not attempt to check, repair or replace fluid fill tires without the proper equipment.
- Use a clip-on chuck and extension hose. Stand to the side of the tire when filling.
- Always maintain tire pressure at **12 PSI. DO NOT** under or over-inflate tires.
- Rear tires have split rims. Release tire pressure prior to loosening any nuts or bolts.
- Never weld or heat the tire rims as this could cause a tire explosion or structural damage to the rim.
- Check tires often for cuts, wear, bubbles and missing or lose lug nuts. Check pressure often.
- Fix or replace worn or damaged tires, rims, and hardware.
- Always replace tires with genuine PermaGreen liquid-filled tires and rims.

20

**Pesticide Safety**

The improper use, handling, application, and disposal of pesticide products applied by this machine may cause death or serious injury.

- Read and follow product label and Material Safety Data Sheet (MSDS) precautions for handling, mixing, applying, and disposing of pesticides applied by this machine. Some materials may present health hazards that will require the use of Personal Protective Equipment (PPE). Always wear required PPE.
- Keep required PPE available for use by the operator or mechanic at all times.
- Keep pesticide labels and MSDS available for the operator or mechanic at all times.

19

**Maintenance and service**

Improper maintenance can cause serious injury.

- Lock brakes, stop engine and disconnect spark plug wire. Wait for all movement to stop before adjusting, cleaning or repairing .
- Clean grass and debris from drives, mufflers, and engine to help prevent fires. Clean up oil or fuel spillage.
- Let engine cool before storing and do not store near flame.
- Shut off fuel while storing or transporting. **DO NOT** store fuel near flames or drain indoors.
- Park machine on level ground. Never allow untrained personnel to service machine.
- Use jack stands to support components when required.
- Carefully release pressure from tires and spray system.
- Remove spark plug wire before making any repairs.
- Keep hands and feet away from moving parts. If possible, do not make adjustments with the engine running.
- Keep all parts in good working condition and all hardware tightened.
- Replace all worn or damaged Machine Safety Labels.
- Replace worn or damaged footpads.
- Perform all scheduled maintenance as directed in the Service Manual.

21

**Handling and disposal of hazardous waste products**

Dispose of all hazardous waste products properly.

- Clean up hazardous waste spills immediately.
- Refer to the Pesticide Label for proper handling and disposal instructions.
- Refer to MSDS for proper handling and disposal instructions.
- Wear the Personal Protective Equipment specified on MSDS and Pesticide Labels.
- Before disposing of hazardous waste check with your local regulatory agency.

22

**Replacement parts**

Use of parts other than those supplied by Perma-Green Supreme, Inc. may compromise the safe use of the machine and void the warranty.

Use only genuine PermaGreen parts. Check with your Dealer or at PermaGreen.com for the latest Parts List for your PermaGreen equipment.

23



This product can expose you to chemicals including Ethyl Benzene, Naphthalene, N-Hexane, and Benzene which are known to the State of California to cause cancer and birth defects or other reproductive harm. For more information go to www.P65Warnings.ca.gov

**WARNING**

DO NOT attempt to start or operate this machine until you have read and are thoroughly familiar with this Operator's Manual. Read it now before beginning. All operators and mechanics must be trained before operating this machine!

Supervised Driver's Training

Before beginning training:

Owner MUST read Safety Manual **WARNINGS 1**, Owner's Responsibility; **2**, Supervised Driver's Training; **3**, Minimum Operator's Qualifications; and **4**, Operator clothing and Personal Protection Equipment.

Trainer MUST read Safety Manual **WARNINGS 2**, Supervised Driver's Training; **3**, Minimum Operator's Qualifications; and **4**, Operator clothing and Personal Protection Equipment.

Trainee MUST read entire Operator's Manual before starting or operating this machine.

Read Safety Manual WARNING 5, Safety Devices before starting or operating the Triumph.

**WARNING**

This product can expose you to chemicals including Ethyl Benzene, Naphthalene, N-Hexane, and Benzene which are known to the State of California to cause cancer and birth defects or other reproductive harm. For more information go to www.P65Warnings.ca.gov

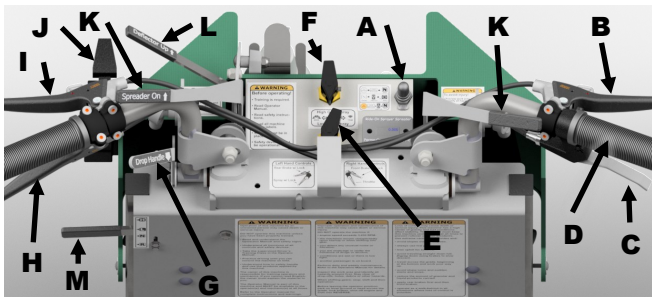

FIGURE 5

At each point where the trainee is to learn a new phase of driving the machine, the trainee **MUST** be provided adequate practice time and demonstrate the ability to satisfactorily control the machine while starting, stopping, turning, getting on and off, along with performing any other task described in that specific phase of the training before proceeding to the next phase.

Machine Safety Devices and controls.

Locate, identify, and explain the function of the following (refer to **FIGURE 5** For location):

- **Machine Safety Labels: Safety Device = (SD)**. A complete listing is found in the Safety Manual section.
- A. **Engine Kill Switch (SD)** turns the engine off and permits it to be started. It is part of the Neutral Safety Switch System to prevent the Triumph from starting in Gear.
- B. **Front Brake Lever (SD)** controls the front service brake on the Transaxle. Pulling the lever activates the Front Brake. The Front Brake Lever can be locked in the pulled position by

pushing the lock button on the lever with your finger. In the locked position the Front Brake is one half of the Parking Brake System of the machine. The Lock is automatically released by pulling the lever again. A Spring controls the amount of force applied to the Front brake.

- C. **Throttle Lever (SD)** is part of the Throttle/Clutch/Operator Presence Control (OPC) System for the machine. The Lever controls engine speed. The engine speed increases as the lever is pulled and the Centrifugal Clutch automatically engages sending power to the Transaxle through a belt and pulley system. Releasing the Throttle Lever decreases engine speed and disengages power to the Transaxle.
- D. **SmartSteer Brake Assist Steering System (SD)** - Interlocked handlebar actuation helps the operator control a fully loaded machine.
- E. **LOW Gear Selector Valve** selects either the **LOW GEAR** Broadcast or Trim nozzle for spraying during **LOW GEAR** Operation. Point valve handle left to enable Broadcast spraying, right to enable Trim spraying, or forward to turn Nozzles off.
- F. **HIGH Gear Spray Selector Valve** selects either the **HIGH GEAR** Broadcast or Trim Nozzle for spraying during **HIGH GEAR** Operation. It operates similarly to the **LOW GEAR** Spray Selector Valve.
- G. **Drop Handle Lever (SD)** unlatches the Handlebars permitting them to drop down for the convenience of the operator and to permit the machine to be used as a walk-behind unit. The Handlebars automatically lock in the down position. Pushing the Lever rearward with the thumb unlatches the Handlebars.
- H. **The Spray Lever** opens a valve when spraying is desired. Like the Brake Levers it has a lock to permit continuous spraying. Additional details about the spray controls will be provided in the Sprayer Operator section of this manual.
- I. **Rear Brake Lever (SD)** controls the rear service brakes. It operates similarly to the Front Brake Lever and is one half of the Parking Brake System.
- J. **Third-Hole Lever** opens and closes the pattern adjustment Slide Plate below the spreader's Third-Hole (left hole looking from the Operator's position). It is to be closed whenever the Deflector is lowered to reduce the amount of granular product distributed to the right side of the machine. It also functions in the partially closed position to balance the spreader pattern. Pulling the lever rearwards closes the Third-Hole. A gray Memory Lock adjusts the partially open setting.
- K. **The Hopper Lever** opens and closes the Hopper to control the release of granular product. Additional details about spreading controls will be provided in the Spreader section of this manual.
- L. **The Deflector Lever** raises and lowers the spreader Deflector to prevent granular material from being spread to the

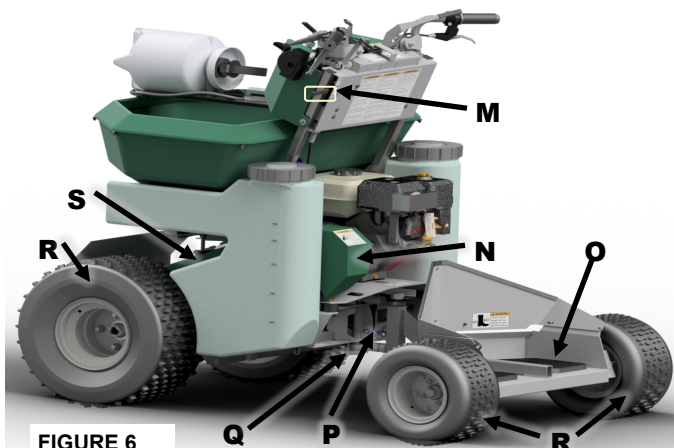

FIGURE 6

right side of the machine while trimming. Moving the Lever rearwards lowers the Deflector.

M. Shift Lever selects a gear on the Transaxle. There are 4 gears available: **REVERSE, NEUTRAL, LOW**, and **HIGH**. A Stop locates **NEUTRAL**. **LOW GEAR** provides a forward speed of **3.5 MPH** and is used on hills, in small areas where detailed trimming is required, and when the Triumph is operated as a walk-behind unit. **HIGH GEAR** provides a forward speed of **5.0 MPH**.

Machine controls

Locate, identify and explain the function of: (refer to **FIGURE 6**)

M. Shift Lever selects a gear on the Transaxle. There are 4 gears available: **REVERSE, NEUTRAL, LOW**, and **HIGH**. A Stop locates **NEUTRAL**. **LOW GEAR** provides a forward speed of **3.5 MPH** and is used on hills, in small areas where detailed trimming is required, and when the Triumph is operated as a walk-behind unit. **HIGH GEAR** provides a forward speed of **5.0 MPH**.

N. Engine Guard (SD) prevents accidental contact with moving belt and pulleys.

O. Slip Resistant Footpads (SD) provide traction for the operator's feet.

P. Articulating Joint Safety Link (SD) prevents the front and rear halves of the machine from unintentionally separating.

Q. Articulating Bolt Lock (SD) prevents unintentional loosening of the lower pivot bolt.

R. Fluid-filled Tires (SD) provide ballast and a lower center of gravity for better stability.

S. Hood/Guard (SD) prevents accidental contact with moving belt and pulleys.

⚠ Read Safety Manual **WARNING 8: Fuel Safety**, before adding gasoline. Use extra care when handling gasoline.

⚠ Read Machine **SAFETY** labels: **W**, Use extra care when handling gasoline and **V**, The engine emits toxic, poisonous carbon monoxide gas, before adding gasoline.

Adding gasoline.
Move the machine outdoors, and

- Use the Approved No-Spill Container and 6-inch-extension.
- When adding fuel, stand at the rear of the Triumph with the Handlebars up.
- Emphasize fuel handling safety.

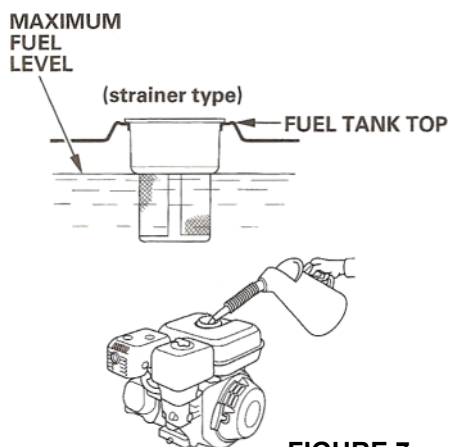

FIGURE 7

Inspect the machine before each use.

⚠ Read Safety Manual **WARNINGS: 9**, Inspect Machine before each use; **17**, Check wheel fasteners; and **18**, Tire Safety, each before starting or operating the machine.

addition to the steps in Safety Manual **WARNING 9**:

- Check and adjust as necessary the Spray Nozzle alignment and pattern.
- Check and adjust the Spreader Control settings as necessary.

Starting, stopping, and parking the machine.

⚠ Read Safety Manual **WARNINGS: 10**, Engines starting Safety; and **14**, Parking, before starting or operating the machine.

- **To start engine:**
 - Locate machine on a flat, level area free from obstacles and bystanders.
 - Shift into Neutral.
 - Lock both Brake Levers.
 - Turn Kill Switch on.
 - Choke engine if necessary.
 - **DO NOT** pull Throttle/Clutch Lever while starting.
 - Pull Starter.
- **To stop engine:**
 - Lock both Brake Levers
 - Shift into Neutral
 - Turn Kill Switch off.
- **To park machine**
 - Stop on level ground.
 - Lock both Brake Levers
 - Shift into Neutral
 - Turn Kill Switch **OFF**.
 - When leaving the machine unattended, close Fuel Valve.
 - Never leave the machine unattended on a slope where someone could disengage the Brakes and the machine could roll.

Safely stepping on and off the Triumph.

⚠ Read Safety Manual **WARNING: 11**, Avoiding slipping or tripping injury; and read Machine Safety Label **WARNINGS: M**, Avoid Slipping Injury and **N**, Avoid Tripping Injury, before starting or operating the Triumph.

Proper shifting techniques.



⚠ **WARNING:** Never shift gears while the machine is moving as this may cause a tip-over or loss-of control.

IMPORTANT: Excessive force applied to the Shift Lever can cause internal Transaxle damage and other damage which is not covered by Warranty.

- **To Change gears:**
 - Release Throttle/Clutch Lever.
 - Bring the machine to a complete stop.
 - Shift into the desired gear. If the machine does not shift easily, move the front of the machine angling it right or left until the Transaxle gears shift easily.

IMPORTANT: Emphasize the necessity of **NOT** forcing the Shift lever, if the transmission does not shift easily.

Demonstrate and instruct the trainee on the following topics:

-  Read Machine Safety Label **WARNINGS** including: **A**, To avoid injury preview work area; **Q**, Improper Operation and improper maintenance; **L**, Pinch point; and **K**, Exposed Moving parts can cause severe injury before starting or operating the Triumph.
-  Read Safety Manual **WARNINGS**: **4**, Operator Clothing and personal protection equipment; **6**, Operation; **7**, Inspecting work area; and **12**, Forward Operation, now before starting or operating the Triumph.

PHASE I: Driving the machine in Low Gear

Refer to **FIGURE 8** and **FIGURE 9** for techniques and principles to use while maneuvering and driving.

Initial training should take place outdoors in a flat open area free of obstructions with the machine in **LOW GEAR** and the Hopper and Tanks empty. Initial training should include the following:

To Drive forward:

- Safely start the machine.
- Safely step onto the operator platform.
- Shift into **LOW GEAR**.
- Unlock Brakes
- Pull the Throttle/Clutch Lever.

To stop:

- Release the Throttle/Clutch Lever.
- Pull the Rear Brake Lever first.
- Pull the Front Brake Lever.

To turn right:

- Pull back on the right handle while simultaneously pushing forward on the left handle. A Stop prevents the machine from jack-knifing.
- Always lean into the turns by shifting your body weight to the inside of the turn.

To turn left:

- Reverse the procedure.

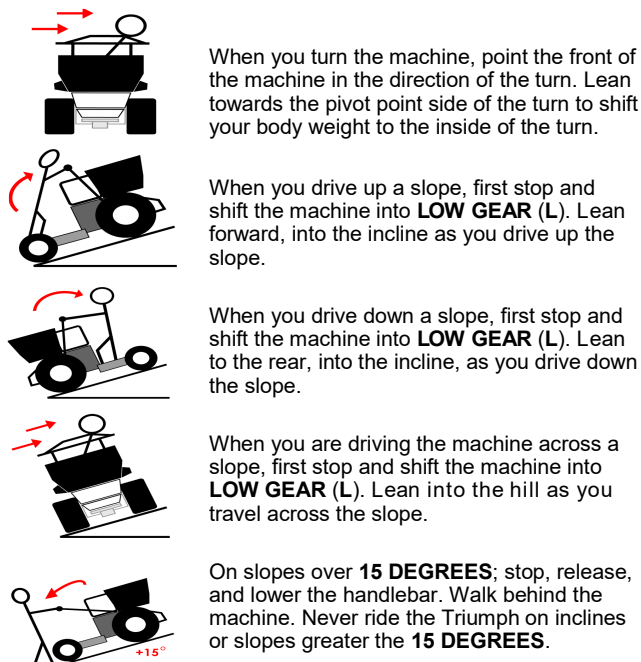

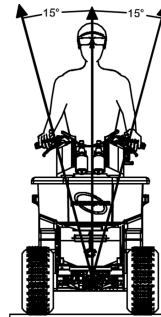

FIGURE 8. Driving Techniques, Triumph Spreader Sprayer

Principles of the Balance Zone (BP)

 **WARNING: DO NOT** operate machine on slopes which exceed **15 DEGREES**. You instinctively stand at your **BALANCE POINT**. When your **BALANCE POINT** is outside the **BALANCE ZONE**, the slope is over **15 DEGREES**. Know the limits of your **BALANCE ZONE**.



Side Balance Zone

The driver's side-to-side **BALANCE POINT** is the centerline passing vertically through his nose. The **15 DEGREE** sidelines indicate the maximum limits of the side-to-side **BALANCE ZONE**.

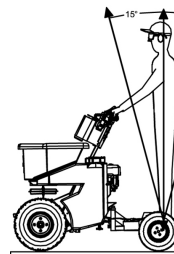

Front/ Rear Balance Zone

The driver's front-to-rear **BALANCE POINT** is the centerline passing vertically through his body. The **15 DEGREE** sidelines indicate the maximum limits of the front-to-back **BALANCE ZONE**.

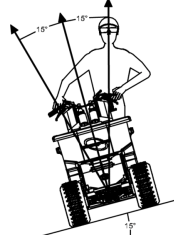

Riding across a 15 degree slope

When the driver's **BALANCE POINT** is directly over the control levers, he has reached the sideline of the side-to-side safe **BALANCE ZONE**.

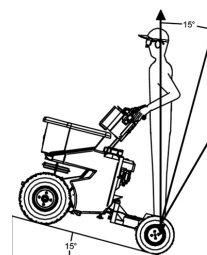

Climbing a 15 degree slope

When the front of the driver is even with the handlebars, he has reached the front sideline of the **FRONT BALANCE ZONE**.

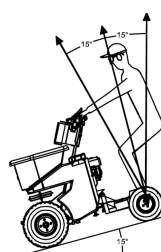

Descending a 15 degree slope

When the driver's arms are full extended and he must squat to reach his **BALANCE POINT**, he has reached the rear sideline of the **REAR BALANCE ZONE**.

FIGURE 9. Balance Zone Principles

PHASE II: Driving the machine in High Gear.

Repeat Phase I training using **HIGH GEAR**. Repeat Phase I Low Gear training procedures as set forth on page 15. However, you will perform these procedures with the Triumph in high gear rather than low gear.

PHASE III: Driving with a load.

- Repeat **LOW** and **HIGH GEAR** Training outlined in Phase I and Phase II with a partially filled Hopper and Tanks

Gradually increase the weight as the trainee demonstrates his ability to control the machine with the increased weight.

Phase IV: Operating the machine as a walk-behind unit.

 Read Safety Manual **WARNING 11**, Avoiding slipping and tripping injury now

Stop, shift into **LOW GEAR** or **REVERSE GEAR**, drop handlebars, and keeping a firm grip on both handles and while operating the machine as a walk behind unit, perform the training procedures outlined in Phases I through IV.

PHASE V: Driving the machine on hillsides.

 Read Safety Manual **WARNING 15**, To avoid loss-of-control, tip-over, and rollover before operating the Triumph on an inclined or slope.

 Read Machine Safety Label **WARNINGS: C**, To avoid Tip-over, rollover, or loss-of-control **T, DO NOT** operate on slopes over **15 DEGREES**; and **P**, Tip-over, rollover, or loss-of-control may cause death or serious injury before operating the Triumph on an incline or slope.

Initial hillside training should take place on a slightly hilly open area free from obstructions with the machine in **LOW GEAR** and the Hopper and Tanks empty.

- The Trainee must be familiar with the **BALANCE ZONE** principles and Driving Techniques before operating on slopes.
- The Trainee must pass the Phases I, II and IV and be totally familiar with all the **WARNINGS** and the hillside driving techniques and principles set forth in the Driver's Training and Operating Manual before operating the machine on a slope or incline. Trainee must never ride the Triumph on any slopes or inclines greater than **15 DEGREES**.
- As the Trainee is able to demonstrate his ability to control the machine on hills as well as his understanding of hillside driving principles and proper techniques; gradually increase the slope.
- As the Trainee progresses, gradually add weight to the Hopper and Tanks.

PHASE VI: Driving over curbs.

- Never attempt to jump a curb at high speed as this may cause a forward tip-over. Instead:
 - Approach the curb or parking block straight on;
 - Stop the machine **12 INCHES** away from the curb;
 - Dismount and drop handles;
 - Shift into **LOW GEAR**;
 - Gradually accelerate up and over curb.
- If machine is unable to climb over a curb:
 - Look for a lower section of curb;
 - If one is not available, approach the curb on an angle and attempt to climb over one wheel at a time;
 - Use ramps to get over the curb. **IMPORTANT:** Avoid high curbs and bottoming out as this can cause machine damage that is not covered by the Warranty.

Phase VII: Backing Up.

 Read Safety Manual **WARNING 13**, Reverse operation now

To back up:

- Stop, shift into Reverse, look behind to make sure the path is clear, and keeping both feet on the operator's platform and a firm 2 handed grip on the handles gradually pull the Throttle/Clutch Lever.

To turn right:

- Pull the right Handle toward you and push the left handle away from you.

To turn left:

- Reverse the procedure.

To stop backing up:

- Release Throttle/Clutch Lever and pull one or both Brake Levers to stop.

Phase VIII: Completing Daily Service Checklist.

 Read Safety Manual **WARNING 19**, Maintenance and Service now **BEFORE** starting or operating machine.

Adjust, Repair, replace, and report any irregularities discovered to your supervisor.

- Clean machine in a designated area. **IMPORTANT: DO NOT** power wash machine. High pressure water will force corrosive fertilizer residue into bearings, linkages, and other parts. Corrosion damage is not covered by the Warranty. Instead use low pressure air regulated to **29 PSI** (200 Kilopascals). Once a week, or as necessary, use low pressure water regulated to **29 PSI** (200 Kilopascals) to wash machine. Start and run machine and blow dry to remove any water.

- Empty Hopper. **NOTE:** Use a dedicated pail or wet /dry vacuum to remove fertilizer so that it can be recycled.

Clean:

- Spinner Platter.
 - Footpads.
 - Nozzles and Nozzle Strainers, If necessary.
 - Hopper opening plate, Third-Hole Slide plate and linkage.
 - Engine cooling fins, Blower housing inlet (Starter), carburetor, governor linkage, Honda Throttle Lever, Throttle Lever and cable.
 - Lubricate and protect the following, using **WD-40** or equivalent:
 - Operating controls and cables.
 - Hopper Opening Plate and Third-Hole Plate.
 - Carburetor and all linkages and springs.
 - Exposed aluminum.
 - Check and record Engine Idle Speed (**MUST NOT EXCEED 1650 RPM**).
 - Check and record Engine Top Speed (**MUST BE 3,450 RPM**).
 - Gauge, record, and adjust Hopper control settings as necessary, including:
 - Third-hole Adjustment Plate.
 - Third-hole Lever Memory-Lock.
 - Hopper opening.
 - Rate Adjustment Knob
 - Check and adjust the Spray Nozzle alignment as necessary.
 - Check and top off engine oil.
 - Check and top off clutch oil.
 - Check for loose or missing fasteners or parts, cracks in metal or welds.
- Check that all **SAFETY DEVICES** are in place and in good working order.

Phase IX: Loading and unloading the machine on a Transport.

 Read Safety Manual **WARNING 16**, Transporting before attempting to load or unload the Triumph from a transport.

Trainee must be instructed how to safely load and unload the Triumph from a transporting vehicle.

Phase X: Additional Service Training

Trainee should be instructed on any additional service he will be required to perform on the Triumph such as, changing Engine and Clutch oil, greasing, etc. Refer to Service Manual for scheduled service requirements and details.

Phase XI: Testing Safety Devices.

 Read Safety Manual **WARNING 5**, Safety Devices before starting or operating the Triumph.

 Read Safety Manual **WARNING 19**, Maintenance and Service before starting or operating the Triumph.

If any Safety Device fails a test, adjust, repair or replace the component before operating the machine.

1. Throttle/Clutch/ Operator Presence Control

Components: Throttle Lever, Throttle Cable, Auxiliary Throttle Return Spring, Multifunction Display (Tachometer), Drive Belt, Idler Pulley, Idler Tension Spring, Transaxle, Honda Engine and components: Honda carburetor and linkage, Honda Governor Spring, Honda Throttle Spring, Honda Throttle Return Spring, and Honda Clutch. All components must be in place and functioning normally.

- Park on level ground free from obstructions and bystanders. Lock both Brake Levers.
- Pull and release Throttle Lever several times. Ensure that the lever moves smoothly and easily and snaps back when released.
- Start engine and verify that the engine speed increases and decreases rapidly and the clutch engages and disengages quickly.
- Engine idle. Ensure the engine idles smoothly without dying and the idle speed on the Multifunction Display does not exceed **1650 RPM**.
- Engine Top end speed. Pull and hold Throttle/Clutch Lever. Confirm that the top end speed is **3450 RPM**.
- Clutch engagement. Shift into **LOW GEAR** and gradually accelerate engine. Confirm that the machine does not move when shifted, or creep at Idle speed. The Clutch shall engage smoothly as the engine is accelerated and propel the machine forward at **3.5 MPH** at full acceleration. No unusual noise should be detected.

2. Neutral Safety Switch System (NSSS)

Components: NSSS Module, Kill Switch, Neutral Switch, Honda Kill Wire, Ground wire, Wire Harness and terminals.

- Park on level ground free from obstructions and bystanders .
- Lock both Brake Levers, shift into **NEUTRAL** and start engine.
- Turn Engine off with Kill Switch. Confirm that the engine starts and Kill Switch works.
- Shift into **LOW GEAR** and repeat the previous test. Confirm that the engine does not start in gear.

3. Brake Systems**A Front Brake System.**

Components: Brake Lever with Lock, Front Brake Cable 1, Front Brake Cable 2, Band Brake, Brake Drum, Band Tension Spring, Sheath Brake pin, Rod Brake pin, 1 washer, Lock Nut.

- Park a fully loaded machine on level ground free from obstructions and bystanders. Start engine.
- While in **NEUTRAL**, push the machine forward. No unusual drag should be felt.
- Pull and release the Front Brake Lever several times. Ensure that the lever operates smoothly and snaps back completely when released. The operating force on the Lever must not exceed **25 POUNDS** of force.
- Shift into **HIGH GEAR**, accelerate to full speed, and pull the Front Brake Lever. Confirm that the machine stops smoothly in less than **8 FEET** and the Brake does not lock up. Brake band must not over heat nor cause unusual drag.

B Rear Brake System.

Components: Brake Lever with Lock, Rear Brake Cable, Band Brake (2), Brake Drum (2), Band Tension Spring (2), Sheath Brake pin (2), Rod Brake pin (2), washer (2), Lock Nut (2).

- Pull and release the Rear Brake Lever several times. Confirm that the lever operates smoothly and snaps back completely when released. The operating force on the Lever must not exceed **25 POUNDS** of force.
- While in **NEUTRAL**, push the machine forward. No unusual drag should be felt. Shift into **HIGH GEAR**, accelerate to full speed, and pull Rear Brake Lever. Confirm that the machine stops smoothly in less than **8 FEET**. Confirm that both Brakes drag equally without causing a change of course, left or right. Brake band must not over heat nor cause unusual drag.

C Both Front and Rear Brake Systems

- Shift into **HIGH GEAR**, accelerate to full ground speed and pull both brake levers. Confirm that the machine stops in less than the length of the machine.

D Parking Brake System.

Components: Front Brake System and Rear Brake System.

- Drive the fully loaded machine up a **17 DEGREE** slope, stop and lock both Brake Levers. Confirm that brakes hold the machine in place.
- Drive the fully loaded machine down a **17 DEGREE** slope, stop and lock both Brake Levers. Confirm that the brakes hold the machine in place.

4 SmartSteer Brake Assist Steering.

Components: SmartSteer Handle Assembly, Steering Brake Cable (2), Band Brake (2), Brake Drum (2), Sheath Brake pin (2), Rod Brake pin, Cable (2), Lock Nut (4),.

- Park the fully loaded machine on level ground free from obstructions and bystanders. Start engine.
- Check right and left Steering Cable condition. Confirm that both cables are tight.
- Check SmartSteer Handle assembly by moving the Handles in opposite directions. Make sure Handles move smoothly and only in opposite directions of each other with minimal free play and that Rubber Mounts are intact.
- Shift into **HIGH GEAR** and drive straight forward.. Confirm that the machine travels in a straight line without pulling right or left and no unusual noise is detected.
- Shift into **HIGH GEAR** and maneuver through a series of lock-to-lock figure eights. Confirm that the machine steers out of the turns with no more than **30 POUNDS** of force required and the Brake Band temperature does not exceed **115 DEGREES** Fahrenheit (46 degrees Celsius), and that the machine does not make any unusual noises.

- 5 **Drop Handle.**
Components: Handlebars, Drop Handle Lever, Release Cable, Latch Pin, and Latch Striker.
 - Pull back on the Steering Handles. Confirm that handlebars stay in an upright position.
 - Push the Drop Handle Lever rearward with your thumb and lower the Handlebars.
 - Confirm that handlebars lock in the down position.
- 6 **Fluid-filled Tire.** Components: Front tires (2) and Rear Tires (2).
 - Read Safety Manual **WARNING 18**, Tire Safety before starting or operating the Triumph.
 - Examine all tires for wear and damage. Confirm that tires are free from visible damage and tread depth exceeds **1/4 INCH**.
 - Rotate each tire so the valve stem is in the **12 O'CLOCK** position and check pressure. Confirm that tire pressure is **12 PSI** (83 Kilopascals) and fluid is visible
7. **Machine Safety Label Visual Test.**
 - Confirm that all Labels are in place and legible.
8. **Machine Guard Visual Test.**
 - Confirm that Hood and Engine Guard are securely fastened in place.
9. **Articulating Bolt Lock Visual Test.**
 - Confirm that articulating Bolt Lock is securely fastened in place.
10. **Articulating Joint Safety Link Visual Test.**
 - Confirm that articulating Joint Safety Link is securely fastened in place.
11. **Slip Resistant Footpads Visual Test.**
 - Confirm that both Footpads are not worn or damaged and are securely fastened in place.

The Drivers Training and Operation Section is completed. Proceed to the Spreader Operation section.

Page left intentionally blank

20



Pesticide Safety

The improper use, handling, application, and disposal of pesticide products applied by this machine may cause death or serious injury.

- Read and follow product label and Material Safety Data Sheet (MSDS) precautions for handling, mixing, applying, and disposing of pesticides applied by this machine. Some materials may present health hazards that will require the use of Personal Protection Equipment (PPE). Always wear required PPE.
- Keep required Personal Protection Equipment (PPE) available for use by the operator or mechanic at all times.
- Keep pesticide labels and MSDS available for the operator or mechanic at all times.

IMPORTANT: The Spreader requires periodic calibration and adjustment to verify the spreader pattern and to verify the correct product delivery rate. Improper application of products can damage turf or reduce the efficacy of applied products.

IMPORTANT: Check and adjust Spreader pattern daily, prior to treating each lawn, and as needed to verify that the Spreader is spreading properly.

IMPORTANT: Whenever you change products or rates of application and at one-week intervals, or more frequently during heavy use, verify that calibration is still valid. Adjust as necessary.

IMPORTANT: You should regularly compare the amount of product used to the number of square feet covered to verify correct delivery rate.

IMPORTANT: Use caution when spreading near desirable vegetation or painted surfaces to avoid damage.

IMPORTANT: Use caution when spreading in windy conditions to avoid damage.

Description of Spreader features, controls, and operation

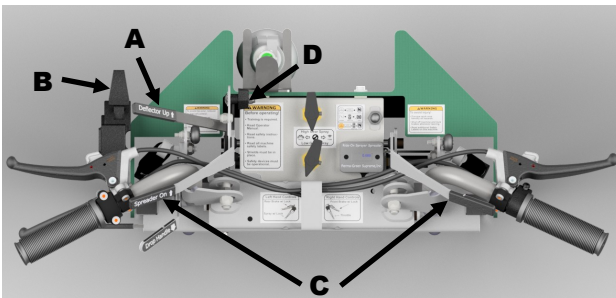

FIGURE 10

This machine uses a familiar 3-hole cyclone type spreader mechanism, and comes factory set to broadcast spread a pattern width of 14 ± 1 FEET (4.3 ± 0.3 meters). Using a 7 ± 1 FOOT (2.1 ± 0.3 meters) overlap travel pattern provides an even distribution of most products. **NOTE:** Actual spread pattern width and overlap may vary based on your calibration (refer to Spreader Calibration in this section). Referring to **FIGURE 10:** A Deflector Lever (A) remotely controls a Deflector to cut off the right side of the spread pattern for trimming. A Third-hole Lever (B) remotely controls a Third-hole Adjustment Plate that should be used with the Deflector to compensate for the amount of product required while trimming and to balance the spreader pattern for even distribution. An opening and closing Hopper Lever (C) remotely controls the delivery of granular material from the Hopper. A Rate Adjustment Knob (D) adjusts the amount of product delivered when the hopper is open. The sprayer can be operated at the same time the spreader is in use, and the seven-foot overlap pattern is also effective for the sprayer.

Operation of Spreader Controls

Spreader Opening and closing.

- Start spreader operation by pushing the Hopper Lever (C) forward to the **OPEN** position.
- To stop spreader operation, pull the Hopper Lever rearward to the **CLOSED** position.

Spreader Rate adjustment.

FIGURE 10.1

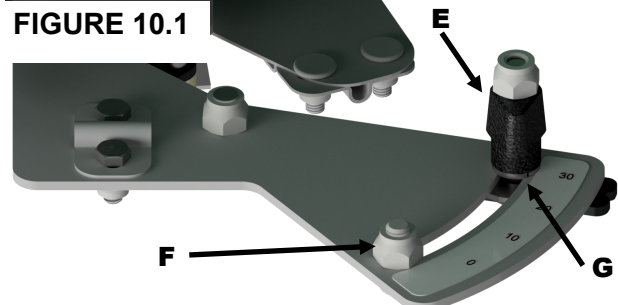

- The **HIGH GEAR** Spreader Rate Adjuster (**FIGURE 10.1**) is located at the lower front of the hopper.
- The **LOW GEAR** Rate Adjuster (**FIGURE 10.2**) is located on the Handlebar.
- Each Rate Adjuster has a stop bolt that is to be Pre-set to the Pre-calibrated rate for the product being applied and the gear selected.
- To spread at the Pre-Calibrated and Pre-set **HIGH GEAR** setting:
 - Referring to **FIGURE 10.1**, position the Black **HIGH GEAR** Rate Adjuster Knob (E) against the **HIGH GEAR** stop bolt (F)
 - Referring to **FIGURE 10.2**, position the Black **LOW GEAR** Rate Adjuster Knob (D) all the way forward in the curved slot on the **LOW GEAR** Rate Adjuster Bracket (I).
 - Moving the Fertilizer lever (J) forward into contact with the **HIGH GEAR** stop opens the hopper to the desired setting.

FIG.10.2

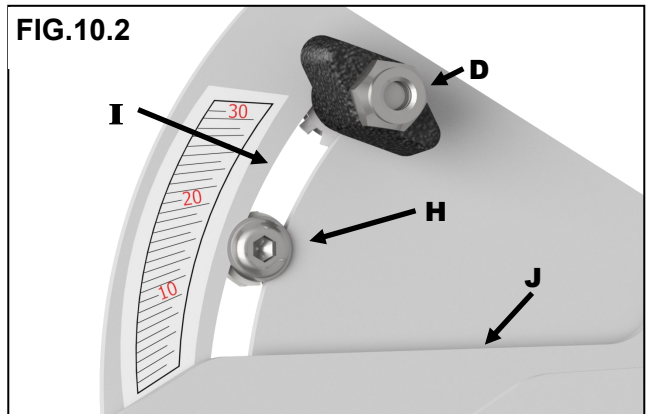

- To spread at the Pre-Calibrated and Pre-set **LOW GEAR** setting:
 - Referring to **FIGURE 10.2**, position the Black **LOW GEAR** Rate Adjuster Knob (D) against the **LOW GEAR** stop bolt (H).
 - Moving the Fertilizer lever forward into contact with the **LOW GEAR** Rate Adjuster Knob opens the hopper to the proper setting.
- To clear a clogged spreader port:
 - Referring to **FIGURE 10.1**, move the Black **HIGH GEAR** Rate Adjuster Knob counterclockwise to the left most position in the curved slot in the **HIGH GEAR** Rate Adjuster Bracket (G).
 - Position the Black **LOW GEAR** Rate Adjuster Knob all the way forward in the curved slot on the **LOW GEAR** Rate Adjuster Bracket.
 - Move the machine to an area where any fertilizer discharge

Spreader Operation

can be collected and recycled or will not damage desirable turf.

- Move the Fertilizer lever forward to open the hopper and clear the clog.
- Return the Black Rate Adjuster Knobs to their previous settings.

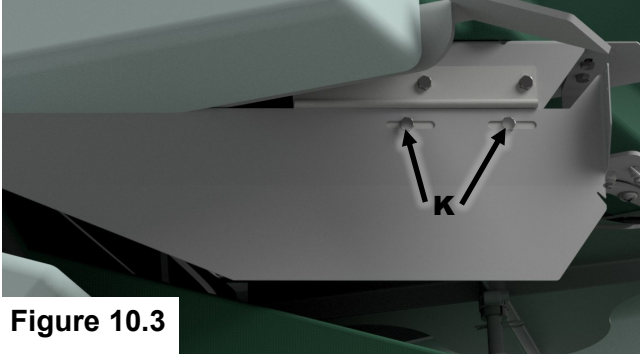

Figure 10.3

- Deflector Adjustment:
 - Referring to FIGURE 10.3. The deflector should stop the spread pattern at the outside edge of the right tire.
 - To adjust the pattern, loosen bolts (K).
 - Move the deflector forward to narrow the pattern or rearward to widen the pattern.
 - Retighten the bolts and test pattern. Repeat steps till proper pattern cutoff is achieved.

To Pre-Calibrate:

- Follow the Spreader Calibration instructions on **PAGE 23** of the Operator's Manual beginning with the **HIGH GEAR** rate setting.
 - Make initial **HIGH GEAR** adjustments using the Black **HIGH GEAR** Rate Adjuster Knob on the hopper
 - Once your Pre-Calibrated **HIGH GEAR** setting is adjusted, reposition the stop bolt (FIGURE 10.1-F) against the Rate Adjuster Knob (FIGURE 10.1-E) to lock in your Pre-set location. A 3/16" Allen wrench is required.
 - Recheck opening and adjust if necessary.
- Calibrate **LOW GEAR** rate setting;
 - Make initial **LOW GEAR** adjustments using the Black **LOW GEAR** Rate Adjuster Knob (FIGURE 10.2-D) on the Handlebar
 - Once your Pre-Calibrated **LOW GEAR** setting is adjusted, reposition the stop bolt (FIGURE 10.2-H) against the Rate Adjuster Knob (Fig. 10-D) to lock in your Pre-set location. A 5/32" Allen wrench is required.
 - Recheck opening and adjust if necessary.

Deflector operation:

- To raise the Deflector (not shown) out of the path of the granular spread pattern, move the Deflector Lever (Fig. 10-A) forward.
- To lower the Deflector and interrupt the granular spread pattern to the right of the spreader, pull the Deflector Lever rearwards.

Third-hole pattern adjuster operation when using the Deflector:

- To close the Third-hole Adjustment Plate when lowering the Deflector, pull the Third-hole Lever rearwards.
- To open the Third-hole Adjustment Plate (not shown), push the Third-hole Lever (Fig. 10-B) forward.

Using the Third-hole pattern adjuster to balance the granular spread pattern.

- To reduce the amount of granular material spread towards the right side of the machine, move the Third-hole Lever rearward to partially close the Third-hole Adjuster Plate. **NOTE:** The gray sliding Memory-Lock should be positioned to secure the Third-hole Lever at that setting. The Lever pops into the Memory-Lock to hold it in place. The Lever may then be used to close the Third-hole Adjuster Plate and return to your pre-set Memory-Lock position.
- To increase the amount of granular material spread towards

the right side of the machine, move the Third-hole Lever forward to increase the opening of the Third-hole Adjuster Plate.

Spreader Operation

NOTE: For proper spreading the engine RPM (measured with the machine in **NEUTRAL**) **MUST** be maintained at **3,450 RPM**, regardless of whether the machine is in **HIGH** or **LOW GEAR**. If engine RPMs are too low the spread width will be too narrow for effective spreading. If too high, the spread width will be too wide.

NOTE: For proper spreading the spreader **MUST** be calibrated (Refer to Spreader Calibration in this section).

For best results, It is recommended that products be applied using one of the following methods:

Method 1: Make edging pass followed by parallel passes.

- First make a trim-pass, edging around the perimeter of the property and any ornamental beds etc.
 - Pull the Deflector Lever to the rear to lower the Deflector while simultaneously pulling the Third-hole Lever rearward to close the Third-hole Adjuster Plate and reduce the spread width by cutting off the material on the right side.
- Select the appropriate gear for the terrain and turf conditions.
 - Use **LOW GEAR** on inclines, slopes and/or hills and in tight areas.
 - Use **HIGH GEAR** on level and open areas.
- Set the Rate Adjustment Knob to the pre-calibrated rate for the gear selected.
- Pull the Throttle Lever to accelerate while simultaneously pushing the Hopper Lever forward to open the spreader and permit granular material to flow from the Hopper.
 - Make the trim-pass keeping the right side of the granular spread pattern inside the edge of the sidewalk, ornamental beds, etc.
- When it is necessary to stop the machine, simultaneously release the Throttle Lever and pull the Hopper Lever to the rear to stop the flow of granular material.
- After making the trim-pass, stop and push the Deflector Lever and the Third-hole Lever forward to return the Deflector to the

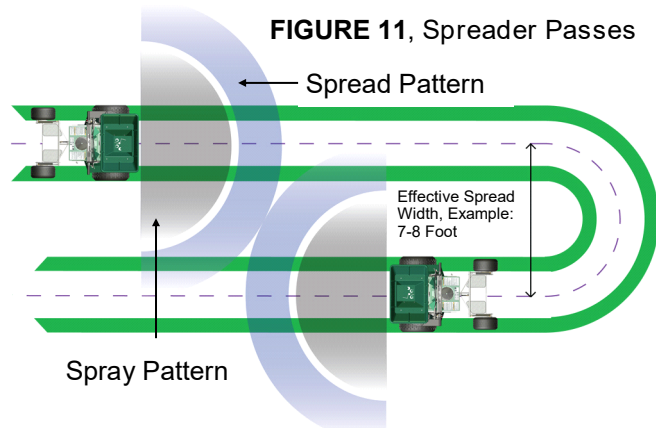

up position and the Third-hole Adjustment Plate to the broadcast setting.

- Change gears if desired. **NOTE:** Return the Rate Adjustment Knob to the pre-calibrated rate for the gear selected.
- Make a header-pass following the path of the trim-pass and keeping the right side of the granular spread pattern inside the edge of the sidewalk, ornamental beds, etc.
- Referring to FIGURE 11, fill the center of the lawn by making parallel passes.
 - Turn on **7-FOOT** centers. **NOTE:** The edge of the spread pattern of most granular materials will fall between the wheel marks of a preceding pass.
 - The first pass should overlap back to the centerline of your wheel tracks of one of the header-pass.
 - As you enter the fertilized area of the header-pass, shut off the hopper as you make a **180-DEGREE** turn.

- Quickly open the hopper as you come out of the turn heading back in the opposite direction with the fertilizer overlapping to the center of your last parallel pass.
- Repeat this process throughout the rest of the lawn.

Method 2: Make a trim-pass and header-pass as in the previous section. Then continue filling in the center making descending spiral passes around the periphery ending in the center. This method helps compensate for an unbalanced pattern distribution because the right side pattern always overlaps the left side pattern.

Either method may be used simultaneously with the spray features on the machine. When trim-spraying the edging pass use the appropriate trim nozzle for the gear selected and spray as needed. When Broadcast-spraying the center area use the appropriate Broadcast nozzle for the gear selected and spray as need

Spreader Calibration

Adjustment of the spreader establishes the correct spread pattern. The center discharge hole establishes the center of the pattern. The right-hand discharge hole (as viewed from the Operator position) establishes the spread pattern on the left-hand side. The left-hand discharge hole establishes the spread pattern on the right-hand side. Calibration establishes the correct application rate and balances the spreader pattern.

Verify that the spreader discharge holes are closed. If the spreader discharge holes are not completely closed, adjust the length of the control cable running from the controls on the left handlebar down the handle to the outer hopper control plate by loosening and repositioning the locknuts.

If you did not purchase a calibration kit with your Triumph, obtain the following materials:

- Eleven collection pans, **3 to 4 INCHES** (8 to 10 centimeters) high and about **1 FOOT** (0.3 meter) square (i.e., aluminum roasting pans)
- A clear graduated tube, **1/2-Inch** (13 millimeter) internal diameter, **3 to 4 INCHES** (8 to 10 centimeters) tall (to act as a graduated cylinder for measuring the collected fertilizer pellets) Use a thin-tipped permanent marker to mark the tube at **QUARTER-INCH** (6 millimeter) increments all the way up the tube.
- Clear, graduated **ONE QUART** (one liter) measuring cup
- Stop watch or wristwatch.
- This owner's manual, and a pencil to record your collection amounts.

Example Calibration procedure. IMPORTANT: *The actual settings for the fertilizer you are using will be different.*

Establish the spreader Rate adjustment and calibration adjustment for a fertilizer to be applied at the rate of **3 POUNDS / 1,000 ft²** (1.36 Kg / 93 m²).

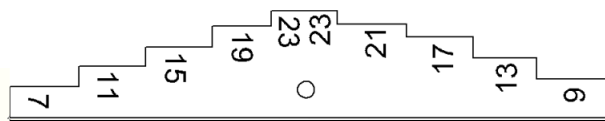

FIGURE 12, Calibration Gauge

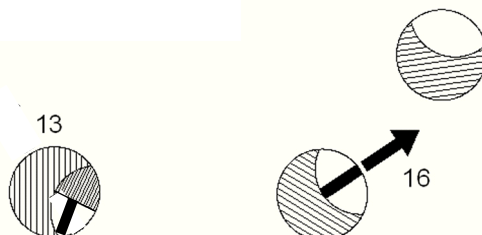

FIGURE 13, Spreader Setting

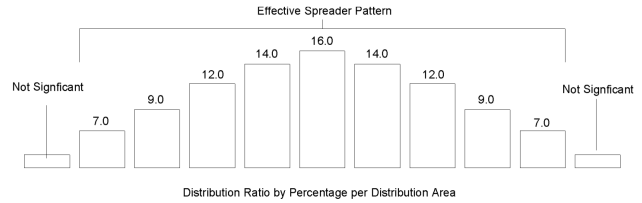

FIGURE 13A, Spread distribution

Place the spreader operating lever in the **CLOSED** position.

- Open the Hopper and using the Calibration Gage (**FIGURE 12**) provided with the machine as shown in **FIGURE 13**, set the center hole opening to **16**. Position the Rate Adjustment Knob against the Hopper Lever and tighten the knob.
- Close and open the Hopper several times and confirm hole opening.
- Adjust Third-hole setting.
 - Without changing the Rate Adjustment Knob setting, open the Third-hole and insert the Calibration Gage, orientated as shown in **FIGURE 13**, in the Third-hole.
 - Using the Third-hole Lever, position the Third-hole Adjustment Plate against the Calibration Gage and position the Memory-Lock until it pops into the Lever and locks its position.
 - Remove the Calibration Gage.
 - Close and open the Third-hole several times and verify the Third-hole setting is **13**. Readjust as necessary.
 - Record both the Calibration Gage setting and the Memory-Lock setting for future use. **NOTE: The correct Calibration Gage setting must be verified from time to time.**
 - The Memory-Lock setting is adequate for reference in the field, but it must be adjusted to the Calibration Gage during the Daily machine Servicing.
- Determine the effective spread width of the granular product:
 - Place **11** calibration pans in a line on two-foot centers on a paved area such as a parking lot. **NOTE:** Checking the effective spread pattern and adjusting the distribution pattern requires multiple passes over the calibration pans. This process is done on a paved area to avoid burning the vegetation by over-fertilizing, and to allow the product to be collected and reused.
 - With the material to be spread loaded in the spreader, make at least three passes from the same direction over the pans in a path perpendicular to the line of pans while spreading material.
 - Pour the contents of the first pan on your far left into the graduated cylinder or clear tube. Measure and record the material deposited. Dump the collected pellets back into the bag or hopper. Repeat this measurement for each pan, one by one, until all eleven pans are emptied and recorded.
 - The distribution pattern should be balanced as in **FIGURE 13A** with a higher amount of product, collected in the center pan and tapering off equally to both sides. **NOTE:** The distribution pattern shown in **FIGURE 13A** represents an ideal pattern, which will not be reproducible in the field. The numbers are used for reference only.
 - To balance the distribution pattern for the right side, move the lever as necessary to increase or decrease the opening in the adjustment hole. Reset the memory lock.
 - Repeat the passes over the pans and measure the material deposited in the pans. Readjust the openings as necessary until the distribution pattern meets the requirements.
 - The effective spread width is the measured distance between the left and right pans that contain **50%** of the volume of the center pan.
 - Record each opening setting for future recalibration.
- Determine the Rate Adjustment Knob setting which delivers the desired amount of fertilizer for the calibrated effective spreader width (above) for both **HIGH GEAR** and **LOW GEAR** speeds.

- Measure **AND RECORD** the amount of time it takes to spread **1,000 ft²** (93 m²) of area. **NOTE:** The machine is designed to operate at a full throttle engine speed of **3450 RPM** while in **NEUTRAL**. Check engine speed with the tachometer and adjust to **3450 RPM** if needed (see Adjusting Engine speed to **3450 RPM** in the Service Manual section). Keeping the engine speed constant, helps insure that the application rate remains constant.

Length of a 1,000 Square Foot calibration course	
Effective Spread Width	Length of Course
7	143
8	125

- Create a test course based on the effective Spread Width from the table above. **EXAMPLE:**
 - Triumph comes set from the factory to an effective *spread and spray width of 7 FEET, which can be accomplished by making 7 FOOT center-to-center parallel passes overlapping approximately 50 PERCENT of the last pass.* Measure a distance equal to the of **143 FEET** (44 meters) over turf. This will provide a spread area of approximately **1,000 ft²** (93 m²). The effective material spread width for many products is **7 FEET**; therefore, **7 x 143 = 1,001 ft²** (93 m²). **NOTE:** If your calibrated effective spread width is 8 feet, you will use **8 x 125 = 1000 ft²** as the basis for making the following calculations.
 - With the machine traveling in **HIGH GEAR** at full throttle, use a stopwatch or wristwatch to measure **AND RECORD** the time required to travel the **143-FOOT** (44 meter) turf course. The normal time is approximately 20 seconds ± 1 seconds.
 - With the machine operating in **LOW GEAR** at full throttle, **RECORD THE TIME** required to cover the **143-FOOT** (44 meter) turf course. The normal time is approximately **28 SECONDS ± 1 SECOND**.
- Measure and adjust the output of the spreader to deliver **3 POUNDS** (1.36 Kg.) per **1,000 ft²** (93 m²).
 - Place a ground cloth on a paved area.
 - Place enough product in the Hopper to conduct several delivery rate checks.
 - Drape a drop cloth over the Hopper to contain and deposit the product spread onto the Ground cloth.
 - With the machine in **NEUTRAL**, accelerate the engine to full speed and open the Hopper for the actual time you recorded for the **HIGH GEAR** time test above (from our example we will use **20 SECONDS**).
 - Move machine off Ground cloth and weigh the product collected.
 - If the product collected weighs less that **3 POUNDS** (1.36 Kg), reposition the Rate Adjustment Knob to a higher setting on the Rate Scale to increase the opening in the Hopper. Repeat the collection test and readjust as required.
 - Once the proper rate has been established **RECORD** the Rate Adjustment Knob and Calibration Gage settings for future use.
 - Repeat the procedure for the **LOW GEAR** time (for our example we will use **28 SECONDS**).

20



Pesticide Safety

The improper use, handling, application, and disposal of pesticide products applied by this machine may cause death or serious injury.

- Read and follow product label and Material Safety Data Sheet (MSDS) precautions for handling, mixing, applying, and disposing of pesticides applied by this machine. Some materials may present health hazards that will require the use of Personal Protective Equipment (PPE). Always wear required PPE.
- Keep required Personal Protection Equipment (PPE) available for use by the operator or mechanic.
- Keep pesticide labels and MSDS available for the operator or mechanic.

IMPORTANT: The Sprayer requires periodic calibration and adjustment to verify the sprayer pattern and to verify the correct product delivery rate because improper application of products can damage turf or reduce the efficacy of applied products.

IMPORTANT: Check and adjust Broadcast Spray pattern daily, prior to treating each lawn, and as needed to verify that the nozzles are properly aligned and spraying properly.

IMPORTANT: Whenever you change products or rates of application and at one-month intervals, or more frequently during heavy use, verify that calibration is still valid. Adjust as necessary.

IMPORTANT: You should regularly compare the amount of product used to the number of square feet covered.

IMPORTANT: Use caution when spraying near desirable vegetation or painted surfaces to avoid damage.

IMPORTANT: Use caution when spraying in windy conditions to avoid damage.

IMPORTANT: The Triumph spray system is designed to apply Low Volume spray solutions at the application rate of approximately **1 QUART PER THOUSAND SQUARE FEET** (0.95 L / 93 m²). An optional kit is available with nozzles sized to apply approximately **½ GALLON PER THOUSAND SQUARE FEET** (1.9 L / 93 m²). Products that require higher application rates than these are not suitable for use in the Triumph.

IMPORTANT: Install the Tank Agitator Kit T 000593 when working with water insoluble products. High rate of such products may clog the spray system.

IMPORTANT: It is recommended that a compatibility jar test be conducted prior to mixing any product or products in Triumph.

Description of Sprayer features, controls, and operation

The spray pattern and spray rate are controlled by the engine speed, pump pressure, and the nozzle orifice. Referring to **FIGURE 14:** A Pressure Unloader Valve (A) at the lower right rear of the front frame controls pump pressure. There is a Suction Shutoff Valve (B) located at the lower left rear of the front frame. The Drain Valve (C) can be used to flush the spray system, drain the tanks or fill the Spot Sprayer bottle (included). Line Strainer K filters the liquid before it reaches the pump. The Tanks are connected together by common Suction and Return flow plumbing to provide a total capacity of **12 U.S. GALLONS** (45.4 liters). **NOTE:** The Triumph is not capable of selectively drawing from only one Tank.

Referring to **FIGURE 15:** There is a pair of low drift nozzles (broadcast (D) & trim (E)) for use while in **LOW GEAR**, and a second pair of low drift nozzles (broadcast (F) and trim (G)) for use in **HIGH GEAR**. [If the Half Gallon Nozzle Kit is installed, the **LOW**



FIGURE 14, Unloader and Shutoff

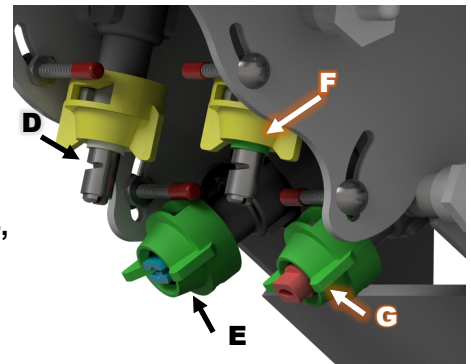

FIGURE 15, Nozzles

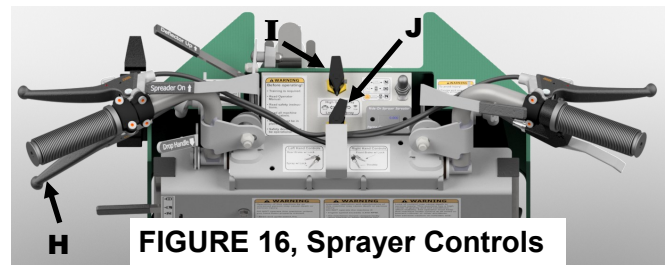

FIGURE 16, Sprayer Controls

Broadcast Nozzle is replaced by a second **HIGH GEAR** Nozzle and both are used simultaneously to spray.]

Referring to **FIGURE 16:** A Spray Lever (H) with lock is mounted on the left handle which allows the operator to spot spray the liquid product while blanket covering the area with granular product. Dashboard mounted Spray Selector Valves (I) control which selects High gear Broadcast and Trim Nozzles. Spray Valve (J) selects Low gear Broadcast and Trim Nozzles.

The sprayer comes from the factory with standard nozzles sized to apply approximately **1 QUART** (.95 liters) per thousand square feet (93 m²) in either gear whether broadcasting or trimming. [An optional Half Gallon Nozzle Kit is available to apply approximately **ONE-HALF GALLON** (1.89 liters) **PER THOUSAND SQUARE FEET.**]

With the **20 PSI** Pressure Unloader Valve installed at the factory, the sprayer has a **7-FOOT** effective pattern width and an **11 FEET** (3.4 meters) overall pattern width using a single front mounted broadcast nozzle, as shown in **FIGURE 17**. The spray distribution pattern allows the use of a **7-FOOT** (2.1 meter) overlap spreader travel pattern to achieve an even and complete coverage of the sprayed product on the entire turf area by overlapping the edge of the last spray pattern approximately **2 FEET** (.61 meter). Using a trim nozzle provides an even finished distribution over a spray pattern of **3-FOET** (.91 meters) on the surface being treated.

If your calibrated effective spreader width is 7 feet, the factory settings will enable the sprayer and spreader to be operated at the same time to provide even and complete distribution of both the sprayed and spread products to the entire area.

Sprayer Operation

If your calibrated effective spreader width is 8 feet, install the 30 PSI unloader cap from the Unloader Valve included in the 8 FOOT Spray Kit supplied with the machine and adjust the effective spray pattern to 8 FEET solid spray and an overall width of 14 FEET. trim nozzle provides an even finished distribution over a spray pattern of 4-FEET (1.22 meters) on the surface being treated.

Sprayer Operating Controls

- To select which nozzle will spray, point the Spray Control Valve handle for the gear selected to the desired nozzle either Broadcast or Trim. The front Spray Selector Valve (I) is used for **HIGH GEAR** and the rear Spray selector Valve (J) for **LOW GEAR**. Point Valve Handle left for Broadcast spraying, right for Trim spraying, and forward to prevent spraying for either nozzle.
- To begin momentary spraying, pull the Spray Lever (H) (FIGURE 16) toward the handgrip.
- To stop momentary Spraying, release the Spray Lever.
- To begin continuous spraying, pull the Spray Lever toward the handgrip and lock.
- To stop continuous spraying, pull and release the Spray Lever again.

Applying Products with the Sprayer

NOTE: For proper spraying the engine RPM (measured with the machine in **NEUTRAL**) MUST be maintained at 3450 RPM, regardless of whether you are using **HIGH** or **LOW GEAR**. If engine RPM is too low the spray applied will be more than your Calibrated Rate. If too high, the spray applied will be less than your Calibrated Rate..

NOTE: For proper spraying, the sprayer calibration must be verified (refer to Sprayer Calibration in this section).

NOTE: Unless the optional One Half Gallon Spray Kit is used, Triumph is intended to spray using only one Nozzle at a time.

It is recommended that the products be applied using one of the following methods for best results.

Method 1: Make edging pass followed by parallel passes.

- Make trim pass around the perimeter of the property and any ornamental beds spraying as needed.
 - Select the appropriate gear for the terrain and turf conditions. Use **LOW GEAR** on hills and in tight areas. Use **HIGH GEAR** on level and open areas.
 - Select the appropriate Trim Nozzle for the gear selected and confirm that the other Spray Control Valve is off. Make the edging pass keeping the edge of the spray pattern inside the edge of the sidewalk or ornamental bed, spraying as needed **NOTE:** For best results use a spot sprayer to lightly feather the edge of the spray along the borders adjacent to drives, sidewalks etc.
- When edging pass is completed stop, make a header pass overlapping into the first trim pass.
 - Change gears if desired; and select the appropriate Broadcast Nozzle for the gear selected and check that the other Spray Control Valve is off. [If the Half Gallon Nozzle Kit is installed, both Broadcast Nozzles will be used simultaneously.]
- Fill in the center of the lawn by making parallel passes on 7-FOOT or 8-FOOT centers (corresponding to the Unloader Valve installed) spraying as needed. At the end of each pass, enter into the header pass and make a **180 DEGREE** turn. **NOTE:** Avoid re-spraying the areas within the header pass and trim-pass that were previously sprayed by the effective width patterns.

Method 2: Make trim-pass and header-pass as in the previous section. Fill in the center making squared-off descending spiral passes to the center spraying as needed.

Either method may be used simultaneously with the spreader features on the machine on the center of the lawn. (**NOTE:** For best spray results, you may make separate granular and liquid trim-passes, and/or use a spot sprayer to lightly feather the edge of the spray along the borders adjacent to drives, sidewalks etc.) Refer to Spreader Operation for detailed instructions.

Adjusting Nozzles for proper spray pattern

IMPORTANT: Check and adjust the Spray pattern of **ALL** Nozzles daily, prior to treating each lawn, and as needed to verify that the nozzles are properly aligned and spraying properly.

Adjusting the Broadcast Spray pattern

- Park on a flat, concrete or asphalt surface.
- Referring to **FIGURE 15**, select the **HIGH GEAR** Broadcast Nozzle (**TF-VS 7.5-90** color coded with a green band) by turning the front Spray Control Valve (I) handle to the left. The rear Spray Selector Valve handle (J) must be pointed forward turning off the **LOW GEAR** nozzles. [If the Half Gallon Nozzle Kit is installed, both Broadcast Nozzles will be used simultaneously.]
- With the machine in **NEUTRAL** and running, pull the throttle lever to full operating speed of **3450 RPM**, and pull the Spray Lever.
- Spray for **15 SECONDS** until the spray pattern is visible on the surface. The spray pattern should resemble the **11-14 FEET** spray pattern in **FIGURE 17**. Adjust as follows:
 - Rotate the nozzle body on the pipe nipple so that the spray pattern comes out slightly below parallel with the ground.
 - Adjust the spray nozzle body so that the pattern width, measured from outermost droplets to outermost droplets should be **11 FEET** (3.4 meters) using the **20 PSI** Unloader Valve or **14 FEET** using the **30 PSI** Unloader Valve. Increase the pattern width by raising the nozzle level. Decrease the pattern width by lowering the nozzle level.
- Install a bolt from the user-installed Nozzle locating Kit (enclosed in the parts bag in the Hopper) against the front edge of the nozzle Cap. If the nozzle body has been moved return it to the calibrated setting by touching it to the bolt.
- Repeat the procedure for the **LOW GEAR** Broadcast Nozzle (**TF-VS4-90** color coded with a white band). Remember to turn off the **HIGH GEAR** Spray Selector Valve. [If the Half Gallon Nozzle Kit is installed, both Broadcast Nozzles will be used simultaneously.]

Adjust the trim spray pattern

- Park on a flat concrete or asphalt surface.
- Referring to **FIGURE 15**, select the **HIGH GEAR** Trim Nozzle (**DG Tee Jet 9504 EVS** color coded red) by turning the front

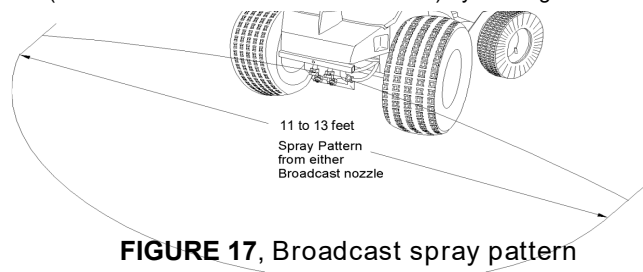

FIGURE 17, Broadcast spray pattern

Spray Selector Valve handle (I) to the right. The rear Spray Selector Valve handle (J) must be pointed forward turning off the **LOW GEAR** nozzles.

- With the machine in neutral and running, pull the throttle lever to full operating speed of **3450 RPM**, and pull the Spray Lever.
- Spray for **15 SECONDS** until the spray pattern is visible on the surface. The spray pattern should resemble the **3-FOOT** spray

pattern in **FIGURE 18**. (4-foot when using the 30 PSI unloader valve installed)

- Adjust as follows:
 - Rotate the nozzle body on the pipe nipple so that the spray pattern is pointed slightly forward.
 - Adjust the spray nozzle body so that the pattern width, measured from outermost droplets to outermost droplets, is **3 FEET** (.91 meters). Increase the pattern width by raising the nozzle level. Decrease the pattern width by lowering the nozzle level.
- Repeat the procedure for the **LOW GEAR Trim Nozzle (DG Tee Jet 9503 EVS** color coded Blue). Remember to turn off the **HIGH GEAR** Spray Selector Valve. [If the Half Gallon Nozzle Kit is installed, both Broadcast Nozzles will be used simultaneously.]

Filling the Tanks

IMPORTANT: When filling, **DO NOT** add concentrated product to an **EMPTY** Tank because the concentrate may be drawn into the plumbing and sprayed through a Nozzle directly onto a lawn

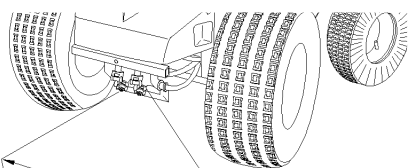

**3 Foot
Spray Pattern
from either
Trim Nozzle**

FIGURE 18, Trim spray pattern

causing turf damage. Instead fill both Tanks halfway and then add concentrate.

IMPORTANT: When filling, **DO NOT** add **ALL** the concentrate to **ONE** Tank because the concentrate will not be evenly distributed and sprayed through a Nozzle directly onto a lawn causing turf damage or lack of efficacy.

There are two methods to fill the Tanks:

Method 1: It is recommended that the Pesticide be Pre-mixed in the proper ratio with water in a Supply Tank, and dispensed equally as needed into the Triumph Tanks.

- Remove both Tank Lids.
- Add Pre-mix desired equally divided between both Tanks. **DO NOT** overfill.
- Replace both Tank Lids checking to be sure the Lid Gaskets are in place.

Method 2: Add Pesticide concentrate in the proper ratio with water directly to the Tanks.

- Remove both Tank Lids.
- Using the Gallon marks on the rear of the Tanks calculate the amount of fill desired for each Tank separately. Refer to Calibration instructions in this section for additional help.
 - Calculate the amount of water required for each Tank.
 - Calculate the amount of Pesticide required for each Tank.
- If the Tanks are empty or nearly so, add one half of the water required then add Pesticide required followed by the remaining water.

Calibrating the Sprayer

Calibrate machine ground speed to **143 FEET** in **20 SECONDS ± 1 SECOND**.

- Set up a **143 FOOT** long test course. Measure a distance of **143 FEET** (44 meters) over turf.
- Measure the elapsed time it takes to travel the **143 FOOT** test course. Your elapsed time must be **20 SECONDS ± 1 SECOND**.
- If your elapsed time is different:
 - With the machine in neutral run the engine at full throttle. Check and adjust engine RPM to deliver an elapsed time of

20 SECONDS (normally **3450 RPM**).

Bucket check **HIGH GEAR** Nozzle output.

- With the machine in neutral and both Brakes locked, start the engine.
- Select the **HIGH GEAR** Broadcast Nozzle using the **HIGH GEAR** Spray Selector Valve (I). Turn off **LOW GEAR** Spray Selector Valve (J).
- Place a catch receptacle in position to catch the entire spray pattern from the Nozzle. [If the Half Gallon Nozzle Kit is installed, approximately **ONE HALF GALLON PER THOUSAND SQUARE FEET** is applied.]
- Pull the Throttle Lever to accelerate the engine to **3450 RPM**.
- Pull the spray lever to begin spraying. Spray for **1 MINUTE**, collecting the nozzle output.
- Measure the collected spray.
- [If the Half Gallon Nozzle Kit is installed, approximately **ONE HALF GALLON PER THOUSAND SQUARE FEET** (1.9 L ± 0.95 milliliters) is applied.]
- Correctly align **ALL** Nozzles. Refer to Adjusting Nozzles for proper spray pattern in this section.

Locking in the Nozzle Position

Once the machine is properly calibrated, the angle of the nozzle bodies can be locked with the user installed Nozzle Stop Kit

Nozzle	20 PSI 7-Foot turns	30 PSI 8-Foot turns
High gear Broadcast TF-VS7.5-90, green	96 oz.	112 oz.
Low gear Broadcast TF-VS4-90, white	76 oz.	86 oz.
High gear Trim DG 9504, red	34 oz.	44 oz.
Low gear Trim DG 9503, blue	26 oz.	34 oz.

Output from the Nozzles must be plus or minus 15%.
If the output from a nozzle is significantly outside the limits, refer to **SECTION 4**, Troubleshooting.

(shipped in the Parts Bag in the Hopper). If the nozzle body is moved, you will instantly be able to return it to the proper position contacting the bolt.

Insert bolt (A) through the slots in the nozzle mounting plates. Tighten lock washer and nut so the bolt touches the front side of the nozzle cap. Add Protective cap. Repeat the process for each nozzle body.

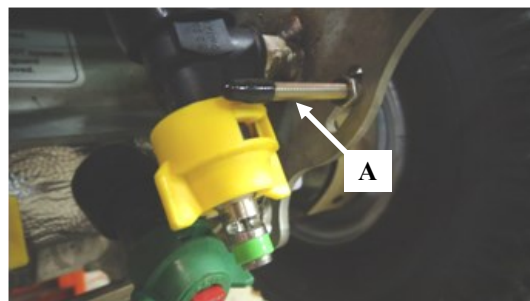

Calculating the Spray Mix Rate

Once the machine is properly calibrated, each quart of spray mix must contain the amount of Pesticide concentrate specified on the Pesticide label to treat **1,000 SQUARE FEET**.

If your Pesticide label gives you the application rate in ounces per thousand:

- Multiply (ounces per thousand) times 4 to make **1 (ONE) GALLON** of spray mix measured in (**OUNCES PER GALLON**).
 - Example: The label calls for (**1.1 OUNCES PER THOUSAND x 4 = 4.4 OUNCES PER GALLON**)
- Multiply (ounces per gallon) times the number of gallons of spray mix you wish to make.
 - Example: (**4.4 OUNCES PER GALLON**) x **12 GALLONS** = **52.8 OUNCES** of product. Mix **52.8 OUNCES** of product with enough water to make 12 gallons of spray mix)
- If your Pesticide label gives (**PINTS PER ACRE**), you must convert (Pints per acre) to (ounces per thousand) using this formula:
 - Multiply (pints per acre) times **.367** to get (**OUNCES PER THOUSAND**).
 - Plug (**OUNCES PER THOUSAND**) into the first step to calculate (**OUNCES PER GALLON**).

NOTE: If the Half Gallon Nozzle Kit is installed, each one half gallon of spray mix must contain the amount of Pesticide concentrate specified on the Pesticide label to treat 1000 square feet.

Spot Sprayer Operation

The Spreader Sprayer includes a hand-carried and hand-operated bottle used to apply spray in areas that the Spreader Sprayer cannot reach. When not in use, the Spot Sprayer is carried in a machine-mounted bracket. Triumph provides room for an optional second Spot Sprayer. The Spot Sprayer holds enough spray to cover approximately **500 ft²** (46.5 meters²). [If the Half Gallon Nozzle Kit is installed and refilled from the Spreader Sprayer, it holds **250 ft²** (23.25 meters²)]. The machine includes a Fill Valve for refilling the bottle from the Spray Tank.

Applying the Spray.

Plan the spray application pattern required to cover the manual application area.

IMPORTANT: Use caution when spraying near desirable vegetation or painted surfaces to avoid damage.

IMPORTANT: Use caution when spraying in windy conditions to avoid damage.

- To spray, invert the spray bottle and squeeze the bottle with enough pressure to create the spray pattern needed.
- To stop spraying, stop squeezing and right the bottle.

Filling the Spot Sprayer.

The spray bottle can be filled directly from the Triumph spray system using the Fill Valve.

- Park Triumph on level ground, shift into **NEUTRAL**, lock both brakes, open Fill Valve, remove the cap, center the Spot Sprayer under the Fill Valve, Throttle up the engine, and dispense the spray mix into the spray bottle.
- When filled release Throttle, close Fill Valve, and install the spray bottle cap.

Cleanup After Use

- Rinse the Nozzle, Nozzle strainer, cap, and spray components in water.
- Inspect the components for wear and damage before reassembly. Replace damaged and worn components.
- Dispose of spray and cleanup water according to the product label and material safety data sheet.

If you are experiencing a problem that is not on the list or are having difficulty, contact PermaGreen Tech Support at 800-346-2001 or support@permagreen.com.

	Check
Engine	
If engine does not start	Transaxle in NEUTRAL Kill Switch ON Gas in tank Fuel Shut off Valve open Choke on Engine flooded Gas Cap plugged Spark plug wire attached Honda Throttle Spring Broken Problem with fuel- Dirty or stale fuel Water in fuel Air cleaner plugged Spark plug damaged or fouled Idle adjustment too low Carburetor- Jet clogged Linkage stuck Neutral Safety Switch System- Starting Module failed Wire nicked and grounding out Transaxle Switch failed Starter pulls hard- Flooded cylinder Oil low Starter pulls easy- Spark Plug loose
Engine Stalls or lacks power	Choke off Gas in tank Fuel Shut off Valve open Honda Throttle Spring broken Gas Cap plugged Air Cleaner plugged Spark Plug damaged or fouled Dirty or stale gas Carburetor- Jet clogged Linkage stuck Oil low When shifting into gear- Starting Module Failed
Engine knocks	Oil low Rocker Arm loose

	Check
Engine will not idle	Idle Adjustment too low Honda Throttle Spring Broken Dirty or stale gas Gas Cap plugged Air Cleaner plugged Spark Plug damaged or fouled Carburetor- Jet clogged Linkage stuck Engine will not return to idle: Throttle Lever or cable damaged or sticking Auxiliary Throttle Return Spring broken Honda Throttle Lever too tight Carburetor linkage stuck Governor Spring broken Governor out of adjustment- Take to a mechanic for adjustment
Engine runs too fast	Governor out of adjustment- Take to a mechanic for adjustment Throttle Lever or cable misadjusted, damaged or sticking
Poor Engine performance	Choke on Problem with fuel- Dirty or stale fuel Water in fuel Debris in Fuel Bowl Fuel line plugged Gas Cap plugged Air cleaner plugged Spark plug damaged or fouled Honda Throttle Spring Broken Carburetor linkage stuck Governor Spring broken Governor out of adjustment- Take to a mechanic for adjustment
Engine Starts in Gear	Starting Module Not working- Replace Ground wire not connected
Preventing fuel related engine Problems	<p>Always use STA-BIL® Fuel Stabilizer and Ethanol Treatment additive in every tank to prevent ethanol related fuel problems. STA-BIL® is the only approved fuel stabilizer for use in PermaGreen equipment.</p> Use PREMIUM unleaded fuel. NEVER use E85 or other high ethanol fuel blend which can damage the engine.

If you are experiencing a problem that is not on the list or are having difficulty, contact PermaGreen Tech Support at 800-346-2001 or support@permagreen.com.

If	Check
Machine	
Machine will not move with engine running	Brakes Locked Drive Belt worn or damaged Idler Tensioning Spring broken or missing Clutch Oil Shift Cable and ends Shift Arm Bolt missing or loose Pulleys loose - Tensioning Idler V-belt Idler Engine Transaxle Front Axle Shaft Key missing Transaxle damage- Oil low (Do not attempt to repair the following) Axle bent Shift Fork bent or broken Other internal damage
Machine creeps or continues moving with Throttle Lever released	Engine Idle speed too high Throttle Lever, cable damaged or sticking Auxiliary Throttle Return Spring broken Honda Throttle Lever too tight Carburetor linkage stuck
Excessive Vibration	Drive Belt slipping or tensioned improperly Loose Engine Bolts Engine Vibration Dampers Damaged Motor Plate Cracked Fasteners loose or missing Frame or welds cracked
Ground Speed Incorrect	Too fast: Engine RPM too high- Throttle Lever/Cable improperly adjusted Too Slow: Engine RPM too low- Throttle Lever/Cable improperly adjusted Belt Slipping, worn or damaged Transaxle in LOW GEAR See Transaxle damage in "Machine will not move with Engine running"

Transaxle Locked	Front Brake locked Steering Brakes too tight, dirty, or damaged Axle Bearing low on grease Internal Transaxle damage- (Do not attempt to repair)
Brakes	
Stop too fast	Brake Cable adjusted too tight Brake Band and Drum dirty Something caught in Brake Band and Drum Rear Wheel Hub low on grease
Stop too slow	Adjust Brake Cable Brake Band and Drum wet or contaminated Brake Cable broken Brake Band or Drum worn or damaged
Pull to one side	Rear Brake opposite the direction of the turn is tighter Rear Brake Cables misadjusted One Brake Band or Drum worn or damaged Rear Wheel Hub low on grease
Squeal	Brake Cable adjusted too tight Brake Band or Drum dirty, worn or damaged Something caught in Brake Band and Drum
Brakes chatter	Brake Cable adjusted too loose Brake Band or Drum dirty, worn or damaged Something caught in Brake Band and Drum
Brake Hot	Brake Cable adjusted too tight Brake Band or Drum dirty or damaged
Steering	
Is difficult	Steering Brake Cable adjusted too loose, damaged or broken. Brake Band or drum worn, dirty, or damaged. Sulky Brakes locked or improperly adjusted Articulating Joint corroded or damaged Rear Wheel Hub low on grease Steering Strut is damaged
Is too easy	Steering Brake Cable adjusted too tight Brake Band or drum dirty or damaged.
Pulls to one side	Front Steering Brake Cable too tight Rear Brake (on opposite side) dragging or locked Rear Wheel Hub low on grease

If you are experiencing a problem that is not on the list or are having difficulty, contact PermaGreen Tech Support at 800-346-2001 or support@permagreen.com.

If	Check
Spreader	
Spinner Platter does not turn	Spinner Platter Tensioning Clamp loose Shaft Coupling Block loose Shaft Coupling Block set screw worn Spinner/Pump Belt loose or damaged Pulley loose- Gearbox Pump Transaxle
Hopper Opening Plate does not move	Plate jammed or dirty Plate Hardware too tight Hopper Opening Plate damaged Hopper Cable loose or damaged Rod Ends loose or damaged
Product does not flow from Hopper	Product blocking one or more holes Agitator damaged or worn Hopper Opening Plate does not move
Third-hole Adjustment Plate does not move	Third-hole Cable or Lever damaged Product jammed
Spreader Pattern Uneven	Third-hole improperly adjusted Spinner Platter damaged or dirty See "Product does not flow from Hopper" See " Spinner Platter does not turn" Engine RPM incorrect
Sprayer	
No Spray output	Tanks empty Spray system not primed Suction Valve closed Clogs - Nozzle Strainer Tank Strainer Nozzle Tip Pump Hoses Spinner/Pump Belt slipping, worn, damaged, or improperly tensioned Loose pulley- Pump Transaxle Gearbox Pump worn, damaged or dirty Spray mix too thick or viscous Frozen fluid

If	Check
Spray output low	Unloader Valve diaphragm dirty or damaged Engine RPM low Clogs - Nozzle Strainer Tank Strainer Nozzle Tip Pump Hoses Spinner/pump Belt slipping, worn, damaged, or improperly adjusted Loose pulley- Pump Transaxle Gearbox Pump worn, damaged or dirty Spray mix too thick or viscous
Narrow Spray Pattern	Spray Nozzles improperly Aligned See "Spray output low"

Page left intentionally blank

Service

WARNING An untrained operator or mechanic can cause an accident with serious injury to himself or bystanders.  Read Safety Manual **WARNING 2**, Supervised Driver's Training and machine safety label **Q**, Improper operation and maintenance before starting, operating, repairing or performing maintenance on the Triumph.

 Read Safety Manual **WARNING 19**, Maintenance and service before starting, operating, repairing or performing maintenance on the Triumph.



Read Safety Manual **WARNING 23**. This product can expose you to chemicals including Ethyl Benzene, Naphthalene, N-Hexane, and Benzene which are known to the State of California to cause cancer and birth defects or other reproductive harm. For more information go to www.P65Warnings.ca.gov

IMPORTANT: Keeping the Triumph B1B Spreader Sprayer operating reliably requires attention to maintenance. Proper maintenance prevents damage to your machine and preventable malfunctions. Proper maintenance is required for the safe operation of the machine.

Use the following timetables to perform routine maintenance.

Engine Service Intervals

Refer to Engine Manual included with this machine for service intervals.

IMPORTANT: Change engine and clutch oil every **50 HOURS**.

Daily Service Checklist.

IMPORTANT: Adjust, repair, replace, and report any irregularities discovered during these checklist inspections to your supervisor.

Adjust, Repair, replace, and report any irregularities discovered to your supervisor.

- Clean machine in a designated area. **IMPORTANT: DO NOT** power wash machine. High pressure water will force corrosive fertilizer residue into bearings, linkages, and other parts. Corrosion damage is not covered by the Warranty. Instead use low pressure air regulated to **29 PSI** (200 Kilopascals) . Once a week, or as necessary, use low pressure water regulated to **29 PSI** (200 Kilopascals) to wash machine. Start and run machine and blow dry to remove any water.
- Empty Hopper. **NOTE:** Use a dedicated pail or wet /dry vacuum to remove fertilizer so that it can be recycled
- Clean:
 - Spinner Platter.
 - Footpads.
 - Nozzles and Nozzle Strainers, If necessary.
 - Hopper opening plate, Third-Hole Slide plate and linkage.
 - Engine cooling fins, Blower housing inlet (Starter), carburetor, governor linkage, Honda Throttle Lever, Throttle Lever and cable.
- Lubricate and protect the following, using **WD-40** or equivalent:
 - Operating controls and cables.
 - Hopper Opening Plate and Third-Hole Plate.
 - Carburetor and all linkages and springs.
 - Exposed aluminum.
- Check and record Engine Idle Speed (**MUST NOT EXCEED 1650 RPM**).
- Check and record Engine Top Speed (**MUST BE 3,450 RPM**).

- Gauge, record, and adjust Hopper control settings as necessary, including:
 - Third-hole Adjustment Plate.
 - Third-hole Lever Memory-Lock.
 - Hopper opening.
 - Rate Adjustment Knob
- Check and adjust the Spray Nozzle alignment as necessary.
- Check and top off engine oil.
- Check and top off clutch oil.
- Check for loose or missing fasteners or parts, cracks in metal or welds.

Break-in Service

(First 10 hours) Checklist

- Change engine oil
- Change Clutch oil
- Grease all fittings
- Check tire pressure
- Check wheel lug nut tightness
- Check tightness of Articulating Joint Bolts
- Test Safety Devices
- Check Drive belt tension
- Check Spinner/Pump belt tension

Every 50 hours (or every 2 weeks) Checklist

(Perform more frequently if operating in wet or dusty conditions)

- Change Engine oil
- Change Clutch oil
- Grease all fittings
- Clean air filter
- Check tire pressure
- Check wheel bolt lug nut tightness
- Check tightness of Articulating Joint Bolts
- Test Safety Devices
- Check drive belt and spinner/clutch belts

Every 100 hours (or monthly) Checklist

(Perform more frequently if operating in wet or dusty conditions)

- Change Engine oil
- Change Clutch oil
- Clean or replace air filter
- Check engine manual for additional service required
- Grease all fittings
- Check tire pressure
- Check wheel lug nut tightness
- Check tightness of Articulating Joint Bolts
- Test Safety Devices
- Check drive belt and Spinner/Pump belts, replace if necessary
- Flush and clean Spray tanks
- Calibrate Spray System
- Calibrate Spreader System

Yearend checklist

- Read Safety Manual **WARNINGS**
- Change engine oil

- Change Clutch oil Clean or replace air filter
- Check engine manual for additional service required
- Grease all fittings
- Check tire pressure
- Check wheel lug nut tightness
- Check tightness of Articulating Joint Bolts
- Test Safety Devices

(continued on next page)

Year-end checklist (continued)

- Check drive belt and spinner/clutch belts, replace if necessary
- Flush and clean Spray tanks
- Run RV anti-freeze or Windshield washer solution through spray system
- Calibrate Spray System
- Calibrate Spreader System





This product can expose you to chemicals including Ethyl Benzene, Naphthalene, N-Hexane, and Benzene which are known to the State of California to cause cancer and birth defects or other reproductive harm. For more information go to www.P65Warnings.ca.gov

Maintenance and service

Improper maintenance can cause serious injury.

- Lock brakes, stop engine and disconnect spark plug wire. Wait for all movement to stop before performing any adjustments, cleaning or repairs.
- Clean grass and debris from drives, mufflers, and engine to help prevent fires. Clean up oil or fuel spillage.
- Let engine cool before storing and do not store near flame.
- Shut off fuel while storing or transporting. **DO NOT** store fuel near flames or drain indoors.
- Park machine on level ground. Never allow untrained personnel to service machine.
- Use jack stands to support components when required.
- Carefully release pressure from tires and spray system.
- Remove spark plug wire before making any repairs.
- Keep hands and feet away from moving parts. If possible, do not make adjustments with the engine running.
- Keep all parts in good working condition and all hardware tightened.
- Replace all worn or damaged Machine Safety Labels.
- Replace worn or damaged footpads.
- Perform all scheduled maintenance as directed in the Service Manual.

 Fluid-filled tires are Safety Devices. Keep pressure at **12 PSI** (83 Kilopascals). **DO NOT** operate machine without Fluid-filled tires. Replace any lost fluid.



 Read Safety Manual **WARNING 18**, Tire Safety before starting, operating or performing repairs or maintenance on the Triumph.

Tires are filled with pressurized diluted RV antifreeze to provide ballast for a lower center of gravity. **EXPLOSIVE SEPARATION OF RIM AND TIRES MAY CAUSE SERIOUS INJURY.**

- **DO NOT** remove fluid from tires.
- All replacement tires must be fluid filled.
- Wear a face shield when checking, filling, and repairing fluid-filled tires.
- Refer to the Service Manual for instructions on repairing fluid filled tires.
- Do not attempt to check, repair or replace fluid fill tires without the proper equipment.
- Use a clip-on chuck and extension hose. Stand to the side of the tire when filling.
- Always maintain tire pressure at **12 PSI**. Do not under or over inflate tires.
- Rear tires have split rims. Release tire pressure prior to loosening any nuts or bolts.
- Never weld or heat the tire rims as this could cause a tire explosion or structural damage to the rim.
- Check tires often for cuts, wear, bubbles and missing or lose lug nuts. Check pressure often.
- Fix or replace worn or damaged tires, rims, and hardware.

Check Engine and Clutch Oil

IMPORTANT: Low oil level can cause serious engine or clutch damage. Check oil level regularly. Check before operating. Keep oil level between "full" and "add" marks. Do not operate engine if oil level in engine or clutch are below or above the full and add marks.

-  Read Safety Manual **WARNING 14**, Parking before starting or operating the Triumph.
-  Read Safety Manual **WARNING 5**, Safety Devices now.
-  Read Safety Manual **WARNING 21** Handling and Disposal of hazardous waste products before starting or operating the Triumph.



WARNING

This product can expose you to chemicals including Ethyl Benzene, Naphthalene, N-Hexane, and Benzene which are known to the State of California to cause cancer and birth defects or other reproductive harm. For more information go to www.P65Warnings.ca.gov

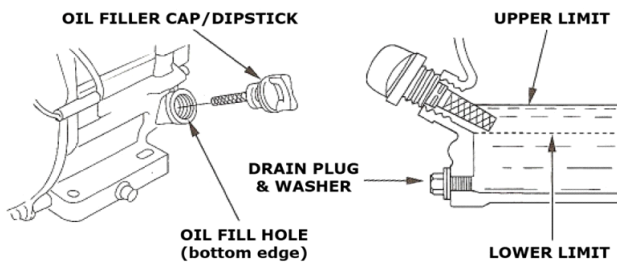

Check engine oil Level (Refer to **FIGURE 19**)

Park safely on level ground.

- Let engine cool.
- Clean around engine dipstick.
- Remove engine **OIL FILLER CAP/DIPSTICK** and wipe it clean.
- Insert engine **OIL FILLER CAP/DIPSTICK** into the oil filler neck as shown but do not screw it in, then remove it to check the oil level.
- If oil is near or below the lower limit mark on the dipstick, fill with the recommended oil (refer to Table Engine and clutch oil type on the next page) to the upper limit mark (bottom edge of the oil fill hole). **DO NOT** overfill. If oil is above the full mark, drain excess oil.
- Replace Oil filler cap/dipstick.

Changing engine oil (Refer to **FIGURE 20**)

Drain the used oil when engine is warm. Warm oil drains quickly and completely.

- Clean around Dipstick and oil drain plug.
- On a level surface, place the machine in a maximum left turn and Lock both Brakes.
- Place an oil drain pan under the drainage hole in the motor plate to catch the used oil.
- Remove oil filler cap/dipstick, drain plug and washer.
- Allow oil to drain completely into pan.
- Reinstall the drain plug and new washer, and tighten the drain plug securely.
- Add recommended oil (refer to Table Engine and clutch oil type on the next page) and use dipstick to check level as described in the "checking engine oil" section above.

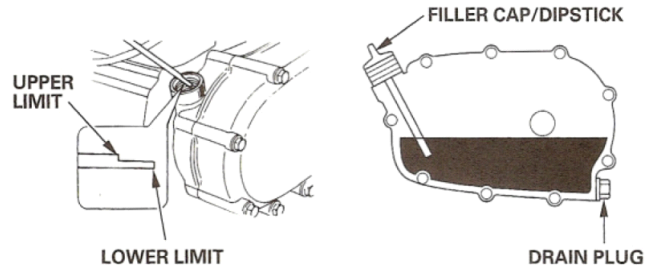

FIGURE 20

Check clutch oil Level

Checking clutch oil (Refer to **FIGURE 20**)

- Remove clutch **OIL FILLER CAP/DIPSTICK** and wipe it clean.
- Insert clutch **OIL FILLER CAP/DIPSTICK** into the oil filler neck as shown but do not screw it in, then remove it to check the oil level.
- If oil is near or below the lower limit mark on the dipstick, fill with the recommended oil (refer to Table Engine and clutch oil type on the next page) to the upper limit mark (bottom edge of the oil fill hole). Do not overfill. If oil is above the full mark, drain excess oil.
- Replace Oil filler cap/dipstick.

Changing Clutch oil

Referring to **FIGURE 20**, Checking Clutch oil: Drain the used oil when engine is warm. Warm oil drains quickly and completely.

- Clean around Dipstick and oil drain plug.
- On a level surface, place the machine in a maximum left turn and Lock both Brakes.
- Place an oil drain pan under the drainage hole in the motor plate to catch the used oil.
- Remove oil filler cap/dipstick, drain plug and washer.
- Allow oil to drain completely into pan.
- Reinstall the drain plug and new washer, and tighten the drain plug securely.
- Add recommended oil (refer to Table Engine and clutch oil type on the next page) and use dipstick to check level as described in the "Checking engine oil" section above.

Temperature Range	Oil Type	Oil Volume-Engine	Oil Volume-Clutch
+50°F (10° C) and higher	SAE 30	0.63 quart (0.6 liter)	0.53 US quart (0.5 liter)
+50°F (10° C) and higher	SAE 10W-30	0.63 quart (0.6 liter)	0.53 US quart (0.5 liter)
+30°F to -22°F (0°C to -30°C)	SAE 5W-30	0.63 quart (0.6 liter)	0.53 US quart (0.5 liter)

Table. Engine and Clutch Oil Type, Volume, and Temperature Range

Operator Presence Control/Throttle/Clutch Adjustment & Service
 Components: Throttle Lever, Throttle Cable, Auxiliary Throttle

⚠ Read Safety Manual **WARNING 5**, Safety Devices before starting or operating the Triumph.

Return Spring (**FIGURE 22**), Multifunction Display (Tachometer), Drive Belt, Idler Pulley, Idler Tension Spring, Transaxle, Honda Engine and components: Honda carburetor and linkage, Honda Governor Spring, Honda Throttle Spring, Honda Throttle Return Spring, and Honda Clutch.

Adjusting Idle speed to 1650 RPM

⚠ Idle speed is part of the Operator Presence Control/Throttle/Clutch Safety Device. Keep the Idle speed less than **1650 RPM** to avoid unexpected machine movement upon starting.

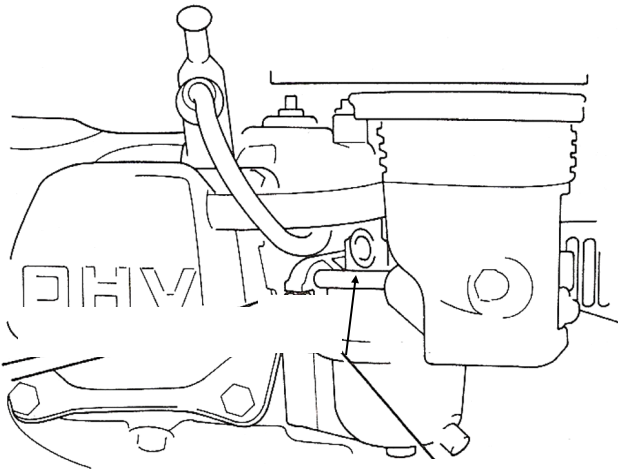

IDLE ADJUSTMENT SCREW

FIGURE 21, Adjusting idle speed

Place machine in a level open area free from obstructions and bystanders, lock both Brakes, shift into **NEUTRAL**, and start engine.

- To raise Idle speed turn Idle Adjustment Screw in.
- To lower Idle speed , turn Idle Adjustment Screw out.

After successfully adjusting engine Idle speed, perform Safety Device Test 1, Throttle/Clutch/Operator Presence Control, **PAGE 18** in "Driver's Training and Operation" section of this manual.

⚠ Engine speed is part of the Operator Presence Control/Throttle/Clutch Safety Device. Keep the top speed at **3450 RPM**. **DO NOT** over-speed engine.

⚠ Read Safety Manual **WARNING 5**, Safety Devices before starting or operating the Triumph.



THROTTLE RETURN SPRING

FIGURE 22, Adjusting engine speed

Adjusting engine speed to 3450 RPM

On a level open area free from obstructions and bystanders, lock both Brakes, shift into **NEUTRAL**, and start engine.

There are 2 methods to adjust the top engine speed.

Method 1: If a small change in engine speed is needed, loosen the jam nut on the Throttle Lever Adjuster.

- To increase top engine speed to **3450 RPM**:
 - Extend the Adjuster and check engine speed. Readjust as necessary. Tighten Jam nut.
- To decrease top engine speed to **3450 RPM**:
 - Retract the Adjuster and test until the proper engine speed is reached. Tighten Jam nut.

Method 2: Reposition the Throttle Cable on the engine.

- Remove the Air Filter and cover, and loosen the Throttle Cable Clamp.
- Tie, or have another person hold, the Throttle Lever tightly up against the Hand Grip. Pull on the cable sheath until **3450 RPM** is reading on the Multifunction Display/tachometer. Tighten the Cable Clamp.

After successfully adjusting engine Top speed, perform Safety Device Test, 1 Throttle/Clutch/Operator Presence Control **PAGE 18** in the "Driver's Training and Operation section of this manual.

Replacing Throttle Lever

- Remove Handgrip
- Loosen Lever tensioning Screw
- Remove cable
- Replace Throttle Lever in reverse order

Replacing Throttle Cable

- Remove Handgrip
- Loosen Lever tensioning Screw
- Remove cable
- Replace Throttle Lever in reverse order

Lubrication

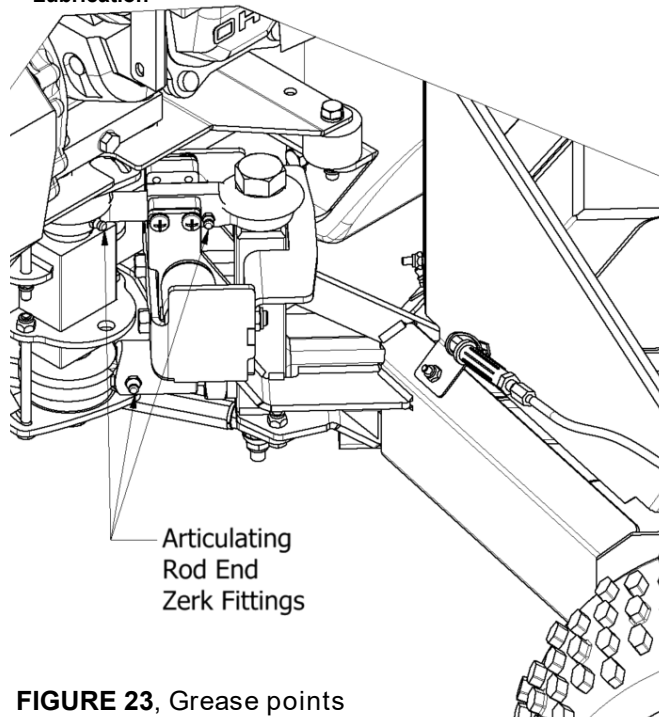

Articulating Rod End Zerk Fittings

FIGURE 23, Grease points

Brake adjustment (Refer to FIGURE 25)

To increase braking, loosen jam nut and extend Turnbuckle Adjuster. Test braking and adjust as necessary. Tighten jam nut.

To decrease braking, loosen jam nut and retract Turnbuckle Adjuster. Test braking and adjust as necessary. Tighten jam nut.

After adjusting, Conduct the Safety Device Test 3, Brake Systems, (page 18) in the "Driver's Training and Operation" section of this Manual.

! Read Safety Manual **WARNING 5**, Safety Devices before starting or operating the Triumph.

Adjusting Steering Brakes (Refer to Figure 25.1)

To increase Steering Brake assistance:

- Hold the adjustment bolt **A** and loosen lock nut **B** to the desired amount.
- Test Steering Brake action and readjust as desired.

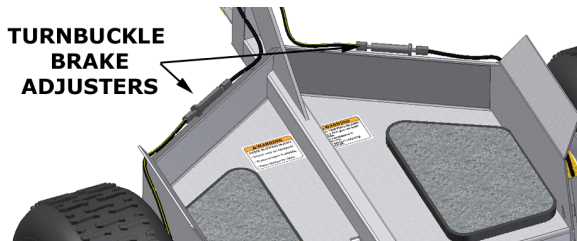

FIGURE 25, Adjusting brakes

- Note: Over adjustment may result in heat build up on brake bands, excessive wear, or brake failure. Symptoms include a high pitched chirping or squealing noise.

To decrease Steering Brake assistance:

- Hold the adjustment bolt **A** and tighten nut **B** to the desired amount.
- Test Steering Brake action and readjust as desired.

! **WARNING:** Over adjusting can cause personal injury due to sudden and unexpected speed and directional changes.

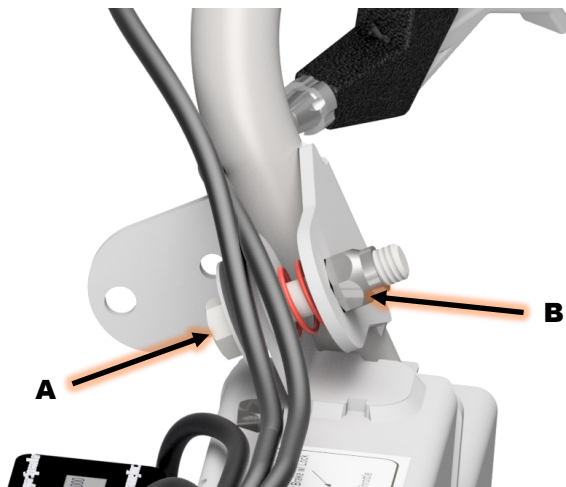
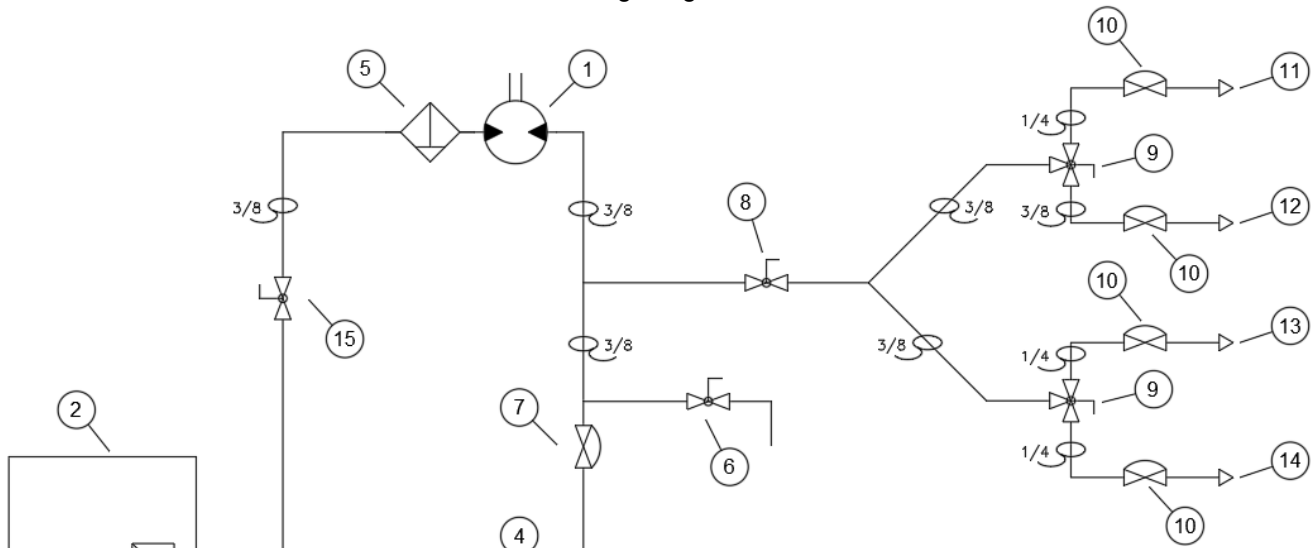

FIGURE 25.1, Adjusting Steering brakes

Plumbing and Electric Schematics

FIGURE 25, Plumbing Diagram



REF	QTY	DESCRIPTION
1	1	T442100 - Triumph Pump
2	1	T204994 - 6 GALLON TANK
3	1	T204996 - 6 GALLON TANK
4	1	T454210 - 1/4" NPT(fem.) Check Valve
5	2	T466690 - 2016 1/4" FPT Poly Strainer Assembly
6	1	R480020 - Valve, 1/4n x 1/4f
7	1	R466437 - Unloader Valve, 20 PSI
8	1	P205010 - Ball ValveX
9	2	T454240 - 701 Selector Valve
10	4	R466222 - Nozzle Body 8 psi
11	1	T205041 - Nozzle Trim, Low Speed
12	1	T205039 - Nozzle Wide, Low Speed
13	1	T205043 - Nozzle Trim, High Speed
14	1	T205037 - Nozzle Wide, High Speed
15	1	T466666 - Ball Valve, Suction
16	2	T500296 In Tank Strainer Assembly

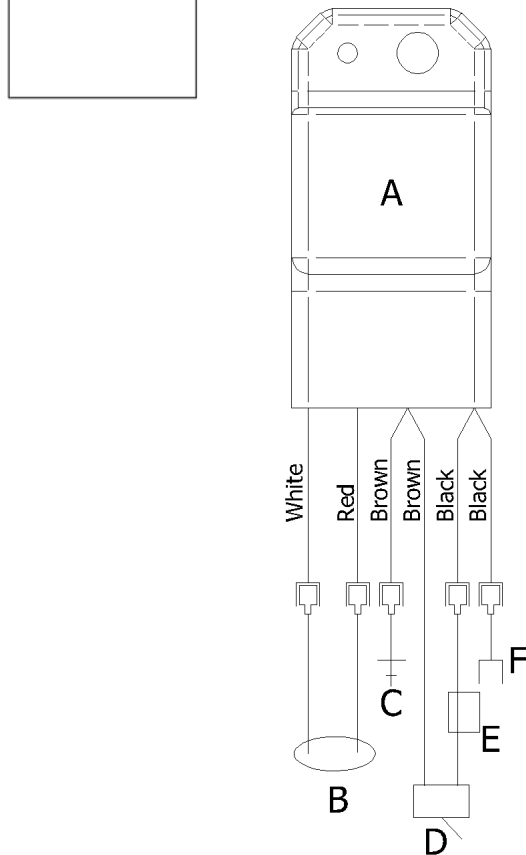

FIGURE 26, Wiring Diagram

- A) Starting module
- B) Neutral switch
- C) Ground to engine
- D) Kill switch
- E) Engine Magneto

Specifications

39

Engine : Honda™ GX200RH2

Clutch: Centrifugal Honda™ wet clutch with 2:1 reduction

Transmission: Tecumseh 855-001D (reverse, neutral and 2 forward gears)

Pump: Flo-jet™ 2 GPM belt-driven diaphragm pump

Front tires: 9.50" - 18" x 8" Kenda Scorpion traction tires (Filled with diluted RV anti-freeze)

Rear tires: 6.50" - 13" x 6" Kenda turf tires (Filled with diluted RV anti-freeze)

Hopper: 150-Pound capacity

Tanks: Twin 6-Gallon tanks
treats 48,000 Ft @32 oz./ft²
or 24,000 Ft @64oz./ft²)

Speed: 5.0 mph (high gear)
3.5mph (low gear)

Fuel tank: 0.82 Honda fuel tank on engine

Fuel Specifications:

ALWAYS mix STA-BIL® Fuel Stabilizer and Ethanol Treatment additive into all fuels used

Premium unleaded (preferred)

Regular unleaded (minimum)

NOTICE: NEVER use E85 or other high ethanol fuel

Oil Specifications on your new Triumph:

- Engine 10w30 (0.63 us quart)
- Clutch 10w30 (0.53 quart)
- Transmission 90 synthetic gear lube

Belt sizes:

1. Drive Belt AX46
2. Spinner Belt AX26

Width of spray: 20 PSI unloader: 11.0 ft. broadcast, 3.0 ft. trim
30 PSI unloader: 13.0 ft. broadcast, 3.0 ft. trim

Broadcast nozzles: (2) TeeJet custom made Turbo FloodJet™ for maximum drift reduction

High gear broadcast -TF-7.5-VS

Low gear broadcast - TF-4-VS

Trim nozzles: (2) TeeJet Drift Guard Even Spray

High gear trim - 9504EVS

Low gear trim - 0503EVS

Dimensions: 56" (L) x 35.5" (W) x 41" (H) [handle down]

Weight: Empty – 440.0 Pounds

Full – 690.0 Pounds + driver

Warranty

WARRANTY

Except as noted below, Perma-Green Supreme, Inc. hereby warrants to the original purchaser of the 2014 Triumph B1B manufactured by PermaGreen Supreme, Inc. that:

1. For 60 Days, PermaGreen will Buy-Back the machine for the full purchase price including freight and tax (Limit one Buy-Back per customer);
2. The Triumph will be free from:

Warranty Coverage	Term
Defects in material and workmanship	15 months
Transaxle, engine or gearbox failure from corrosion perforation of outer case	15 months
Cracking of the Frame and sulky	24 months

PROTECTION PLAN

The Company will provide replacement parts found by the Company to have failed due to the aforementioned causes. Such replacement parts will be provided free of charge to the original purchaser for the time specified above.

COMMENCEMENT OF PROTECTION COVERAGE

Cool-Season Turfgrass Zone	Date of purchase	Date Protection Coverage Begins
Pre-season purchase	November 15 - February 15	February 15, or the first date of use to apply lawn care or ice melt products (whichever comes first)

The Protection Coverage begins on the date of purchase and continues uninterrupted for the entire term listed in the table above, unless noted in the table below:

For the purpose of determining eligibility of the purchaser, the Company defines the North American Cool-season Turf grass Zone as areas north of the Maryland Pennsylvania border or north of **39° 43' N**.

ORIGINAL PURCHASER RESPONSIBILITIES:

- Complete and return a Warranty Registration Card within **30 DAYS** of purchase.
- Perform all recommended maintenance and adjustments in a timely manner as specified in the Operator Manual and Engine Manual.
- Provide transportation to and from the place of warranty repair or Buy-Back.
- Empty, drain and clean the machine prior to taking it in for Warranty repair.
- Provide PermaGreen Supreme, Inc. with prior notification of the need for Warranty Service or Buy-Back.
- Return a Warranty Claim Form to PermaGreen Supreme, Inc. along with the claimed defective part(s) (if required) within **30 DAYS** of warranty repair.

EXCLUSIONS:

No warranty is applicable to any equipment or parts that have been altered, misused, improperly adjusted and/or neglected. Additionally, the warranty does not apply to equipment and/or parts or damaged or in need of repair or replacement due to accidents, disasters, and/or normal wear and tear.

PermaGreen Supreme, Inc. reserves the right to incorporate any changes in design into its products without obligation to make such changes on products previously manufactured.

LIMITATION OF REMEDIES

UNDER NO CIRCUMSTANCES SHALL PERMAGREEN SUPREME, INC. BE LIABLE FOR ANY LOSS OR DAMAGE, DIRECT OR INDIRECT, SPECIAL OR CONSEQUENTIAL, INCLUDING, BUT NOT LIMITED TO, ANY CLAIM FOR LOSS OF PROFITS, LOSS OF SAVINGS OR REVENUE, LOSS OF USE OF EQUIPMENT OR ANY ASSOCIATED EQUIPMENT, FACILITIES OR SERVICE, DOWNTIME, THE CLAIMS OR COSTS OF THIRD PARTIES INCLUDING CUSTOMERS, AND/OR INJURY TO PROPERTY ARISING OUT OF THE USE OF OR INABILITY TO USE THIS EQUIPMENT.